

GEWISS



Sisteme de distributie

 *Energy Box*

20 12



CATALOGUL COMERCIAL

Intuitiv, succint si usor de folosit, catalogul comercial contine toate informatiile despre produsele din categoriile Domotics, EnergyDIN, EnergyBLOC, EnergyBOX si Lighting. Pe langa codurile de produs, se pot gasi tabele selective pentru fiecare gama.



CATALOGUL LIGHTING

Conceput pentru profesionistii din domeniul iluminatului, catalogul descrie toate corpurile de iluminat GEWISS, cu ghiduri de selectie si tabele tehnice, pentru o alegere perfecta si o consultanta tehnica riguroasa.

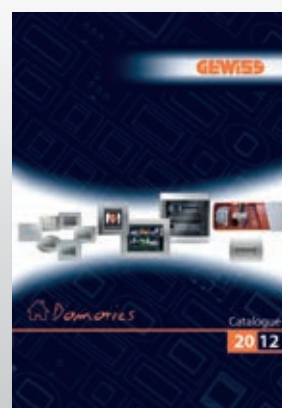

CATALOGUL DOMOTICS

Catalogul Domotics 2012 prezinta toate solutiile dedicate domeniului rezidential si descrie caracteristicile, aplicatiile si avantajele acestora.

SISTEM DE DISTRIBUTIE GEWISS

GEWISS, lider de piata in doze de jonctiune și cutii speciale, oferă, de asemenea, un sistem complet, coordonat gama de tablouri de distributie cu montaj aparent sau ingropat. Tuburile Gewiss, jgheburile din plastic și metal pot conecta elemente ale unui sistem electric integrat.

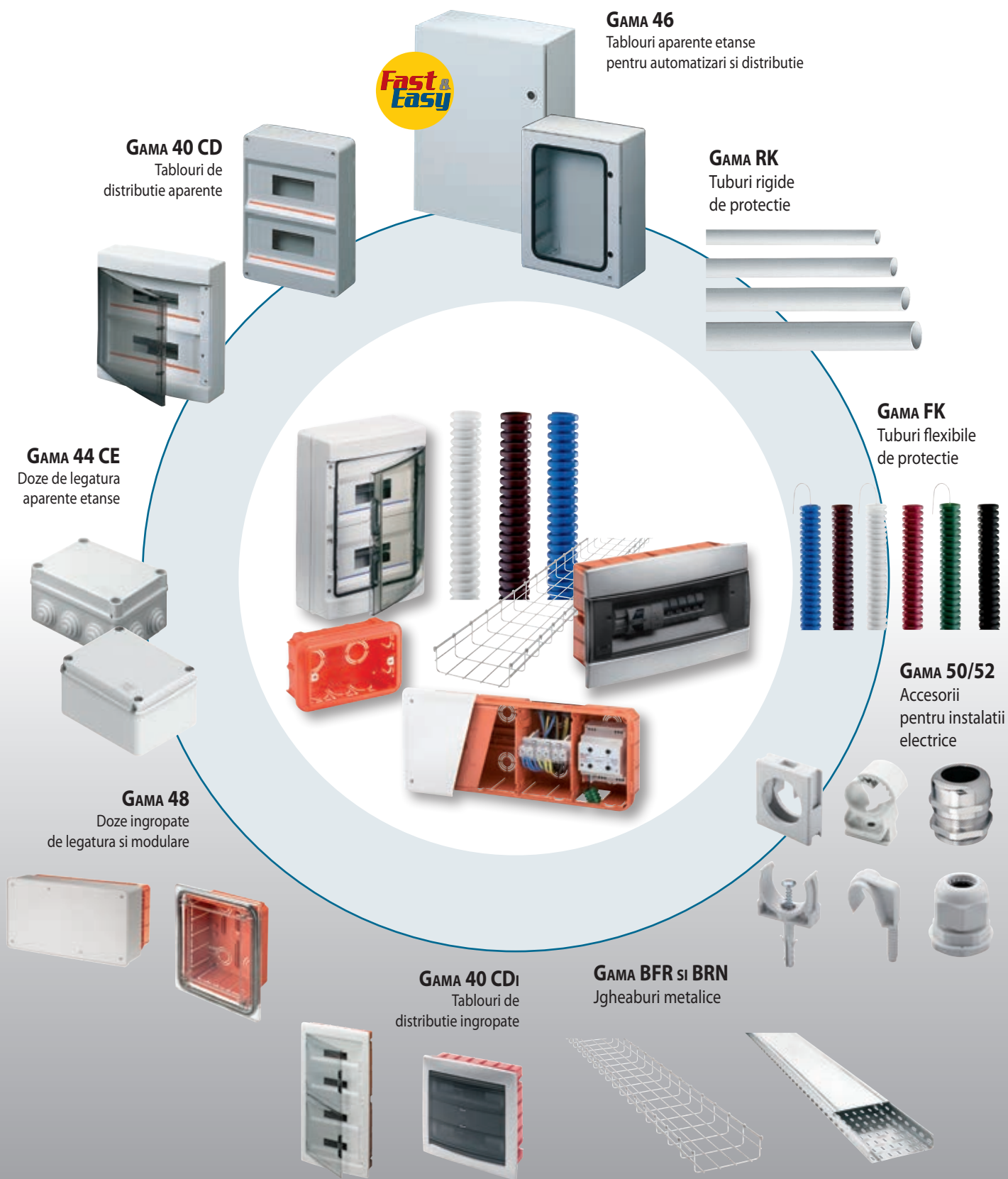

Mai rapid de cablat decat de descris

Functionalitate maxima.

Patru versiuni cu tablouri aparente etanse, pentru automatizari si distributie, oferind mai multe tipuri de material: termoplastice (44 CEP), fibra de sticla termorigida (46 QP), metal vopsit (46 QM) si otelinox (46 QX). toate produsele din aceasta gama sunt caracterizate de o structura rezistentasi de o rapiditate si simplitate in instalare gratie accesoriilor Fast & Easy comune pentru gamele 46 QP, 46 QM si 46 QX.

Aceste tablouri sunt disponibile cu usa plina sau usa transparenta pentru a oferi o maxima flexibilitate si universabilitate in utilizare.



46 QP - Ideal pentru fotovoltaic



Instalare mai rapida cu pana la 40%



Versiuni fara halogen



Cadru extractibil si sina DIN ajustabila

Sina DIN, ajustabila si cu cuplare rapida, este furnizata preasblata si gata pentru fixata in suport. Rama extractibila este fabricata cu sistem metalic de blocare. Suporturile pentru sina DIN si plastroane se fixeaza pe montanti.



Panouri frontale fixate la 1/4 tura

Panourile frontale sunt fabricate pentru a nu se pierde spatiu si se inchid la 1/4 tura. Panourile cu fereastră sunt complete cu sina DIN. Mai mult, panourile pentru sistemul Fast & Easy au prevazute direct pe peretii interni locurile unde pot fi instalate pentru tablourile din 46 QP (excluzand cea de a 7 a dimensiune).

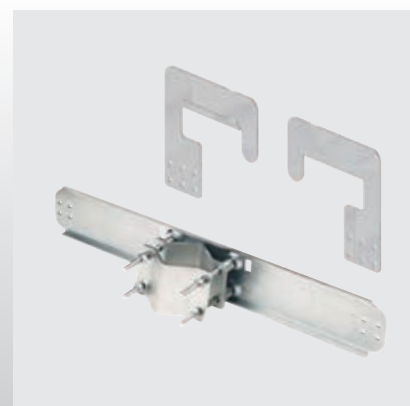

Accesoriile pentru tablouri si mai versatile

Aplicatiile pentru tablourile din 46 QP sunt extrem de largi gratie si paletei largi de accesorii: de exemplu sunt disponibile placi de fixare din metal si material izolant, elemente de fixare pentru intreruptoare de pana la 250 A, sina DIN dubla, usa interioara reversibila din metal sau poliester.

	MATERIAL	COD		INTRERUPATOR AUTOMAT DE PUTERE		SEPARATOR	
		Usa PLINA	Usa TRANSPARENTA	MTX 160c MTX 160 MTX 250	MTX 160c - MTX 160 - MTX 250 COMBINAT CU DIFERENTIALUL SAU IN FORMA DE "L"	MSS 160	MSS 250
							
44 CEP GWPLAST 120 IP55 	GWPLAST 120	GW 44 808	GW 44 818	-	-	-	-
	GWPLAST 120	GW 44 809	GW 44 819	-	-	-	-
	GWPLAST 120	GW 44 810	GW 44 820	GW 44 853 pentru MTX 160c si MTX 160	GW 44 853 pentru MTX 160c si MTX 160	-	-
	GWPLAST 120	GW 44 811	GW 44 821	GW 44 855 pentru MTX 160c si MTX 160	GW 44 855 pentru MTX 160c si MTX 160	-	-
46 QP TABLOU POLYESTER IP65 	Polyester	GW 46 001	GW 46 201	-	-	-	-
	Metal	GW 46 031	-	-	-	-	-
	Polyester	GW 46 002	GW 46 202	-	-	-	-
	Metal	GW 46 032	GW 46 232	-	-	-	-
	Otel inox	GW 46 052	-	-	-	-	-
	Polyester	GW 46 003	GW 46 203	GW 46 570 F	GW 46 570 F	GW 46 570 F	-
	Metal	GW 46 033	GW 46 233	-	-	-	-
	Polyester	GW 46 004	GW 46 204	GW 46 570 F	GW 46 570 F	GW 46 570 F	-
	Metal	GW 46 034	GW 46 234	-	-	-	-
	Otel inox	GW 46 054	-	-	-	-	-
46 QM TABLOU METALIC IP55 	Polyester	GW 46 005	GW 46 205	GW 46 571 F	GW 46 571 F	GW 46 571 F	GW 46 577 F
	Metal	GW 46 035	GW 46 235	-	-	-	-
	Polyester	GW 46 006	GW 46 206	GW 46 572 F	GW 46 572 F	GW 46 572 F	GW 46 578 F
	Metal	GW 46 036	GW 46 236	-	-	-	-
46 QX TABLOU DIN OTEL INOX IP55 	Otel inox	GW 46 056	-	-	-	-	-
	Polyester	GW 46 007	GW 46 207	GW 46 573 F	GW 46 573 F	GW 46 573 F	GW 46 579 F
	Metal	GW 46 037	GW 46 237	-	-	-	-
	Otel inox	-	-	-	-	-	-

NOTE: Configuratiile din tabel sunt valabile numai daca valoarea maxima de curent a intrerupatorului indicat (eventuala valoare a curentului de scurtcircuit, in punctul de instalare) nu depaseste 17kA, sau curentul de scurt circuit asumat, in linie cu intrerupatorul general, nu depaseste 10 kA.

Efectuati controlul termic prin metoda indicata in paginile corespunzatoare din catalogul tehnic.

Seturile se fixeaza cu montanti, panourile din set au inaltimea modulelor de 2.











MTS160 si MTX se fixeaza pe sina DIN cu ajutorul bridelor de fixare incluse in kitul GWD8261. MTX 250 (3p si 4p) are nevoie de kitul GWD8262.

Cuplarea intrerupatoarelor automate MTX pe sina DIN impreuna cu un bloc diferential se monteaza cu ajutorul unor dispozitive speciale de fixare.

In cazul in care cablul intra in tablou din partea de jos este indicata montarea unei placi false pentru a facilita accesul acestuia.

Datorita dimensiunilor diferite (h) dispozitivele sectionatoare MSS si intrerupatoarele automate MTX nu pot fi montate pe aceiasi sina DIN.

Seturile de intrerupatoare capsulate/ sectionatoare prevad instalarea verticala a aparatelor, diferentialul BDS (daca e disponibil) montanduse prin alaturare.

	TABLOU					ACCESORII		
						CONFIGURARE FRONTALA		
						UN SINGUR PANOU	PANOURI	
Dimensiuni (LxHxD) mm	Material	Cod		Nr. module DIN EN 50022	 cu fereastră și sina DIN	 cu fereastră și sina DIN	 Plin	
Usa PLINA	Usa TRANSPARENȚA							
44 CEP GW PLAST 120 IP 55 	200x254x135	GWPLAST 120	GW 44 808	GW 44 818				
	236x316x135	GWPLAST 120	GW 44 809	GW 44 819	8	GW 44 852 8 module		
	316x396x160	GWPLAST 120	GW 44 810	GW 44 820	24 (12x2)	GW 44 853 14 module GW 44 854 24 module (12x2)		
	396x474x160	GWPLAST 120	GW 44 811	GW 44 821	32 (16x2)	GW 44 855 32 module (16x2)		
46 QP TABLOU DIN POLYESTER IP65 	250x300x160	Polyester	GW 46 001	GW 46 201				
		Metal	GW 46 031					
	310x425x160	Polyester	GW 46 002	GW 46 202	36 (12x3)		3 panouri cu câte 12 module	 GW 46 420 F GW 46 425 F
		Metal	GW 46 032	GW 46 232				
		Oțel inox	GW 46 052					
	405x500x200	Polyester	GW 46 003	GW 46 203	54 (18x3)		3 panouri cu câte 18 module	 GW 46 421 F GW 46 426 F
Metal		GW 46 033	GW 46 233					
405x650x200	Polyester	GW 46 004	GW 46 204	72 (18x4)		4 panouri cu câte 18 module	 GW 46 421 F GW 46 426 F	
	Metal	GW 46 034	GW 46 234					
	Oțel inox	GW 46 054						
515x650x250	Polyester	GW 46 005	GW 46 205	96 (24x4)		4 panouri cu câte 24 module	 GW 46 422 F GW 46 427 F	
	Metal	GW 46 035	GW 46 235					
585x800x300	Polyester	GW 46 006	GW 46 206	140 (28x5)		5 panouri cu câte 28 module	 GW 46 423 F GW 46 428 F	
	Metal	GW 46 036	GW 46 236					
	Oțel inox	GW 46 056						
800x1060x350	Polyester	GW 46 007	GW 46 207	180 (36x5)		5 panouri cu câte 36 module	 GW 46 424 F GW 46 429 F	
	Metal	GW 46 037	GW 46 237					

ACCESORII

CONFIGURARE FRONTALA				CONFIGURARE INTERNA			ACCESORII DE SCHIMB		
PANOURI DUBLE	USI INTERIOARE	MONTANTI	SINA DIN	PLACI DE FIXARE	PLACI DE FIXARE	SUPORT SUSTINERE	ALTE ACCESORII		
 Pline	 Material: izolant/ metal	 Pereche	 simpla/ dubla	 Material: metal/ otel (perforat)/ izolant	 H 1 modul: perforat/ plin	 H 2 module: perforat/ plin	 Pereche		
				GW 44 636 GW 44 646				 Bride din rasina GW 44 621	 Incuietoare de siguranta cu maner GW 46 445
				GW 44 637 GW 44 647				 4 bride otel inox GW 46 451	 4 bride otel GW 46 446
				GW 44 638 GW 44 648					
				GW 44 639 GW 44 649					
				GW 46 401 GW 46 461 GW 46 408			GW 46 551	 Clema piulita GW 46 450	 4 bride din otel inox GW 46 451
1 panou dublu GW 46 475 F	GW 46 414 GW 46 564	GW 46 435 F	GW 46 430 F GW 46 530 F	GW 46 402 GW 46 462 GW 46 409	3 panouri dublu GW 46 440 GW 46 540	1 panou dublu GW 46 480 GW 46 580	GW 46 552	 Set 4 bride din otel inox GW 46 446	 Garnitura pentru cuplarea tablourilor GW 46 449
1 panou dublu GW 46 476 F	GW 46 415 GW 46 565	GW 46 436 F	GW 46 431 F GW 46 531 F	GW 46 403 GW 46 463 GW 46 410	3 panouri dublu GW 46 441 GW 46 541	1 panou dublu GW 46 481 GW 46 581	GW 46 553	 Set montanți pentru fixare GW 46 521F	 Incuietoare de siguranta cu mane GW 46 445
2 panouri dublu GW 46 476 F	GW 46 416 GW 46 566	GW 46 437 F	GW 46 431 F GW 46 531 F	GW 46 404 GW 46 464 GW 46 411	4 panouri dublu GW 46 441 GW 46 541	2 panouri dublu GW 46 481 GW 46 581	GW 46 553	 Buzunar portdocumente GW 46 447	 Set pentru ventilarea fortată a tablourilor IP44 GW 46 448 si GW 46 471
2 panouri dublu GW 46 477 F	GW 46 417 GW 46 567	GW 46 437 F	GW 46 432 F GW 46 532 F	GW 46 405 GW 46 465 GW 46 412	4 panouri dublu GW 46 442 GW 46 542	2 panouri dublu GW 46 482 GW 46 582	GW 46 554	 Pereche prinderi pentru jghebul de tablou GW 46 557 F	
2 panouri dublu GW 46 478 F	GW 46 418 GW 46 568	GW 46 438 F	GW 46 433 F GW 46 533 F	GW 46 406 GW 46 466 GW 46 413	5 panouri dublu GW 46 443 GW 46 543	2 panouri dublu GW 46 483 GW 46 583	GW 46 555	 Manere pentru transport GW 46 591	 Set insertii GW 46 592 F
2 panouri dublu GW 46 479 F	GW 46 419 GW 46 569	GW 46 439 F	GW 46 434 F GW 46 534 F	GW 46 407 GW 46 467	5 panouri dublu GW 46 444 GW 46 544	2 panouri dublu GW 46 484 GW 46 584			

GAMA 40 CD

TABLOURI SI COFRETE DE DISTRIBUȚIE MONTATE APARENT

Funcționalitate și practicabilitate într-un cadru

O gama largă de tablouri și cofrete de distribuție montate aparent pentru diferite aplicații. 40 CD se compune din 4 linii de produse ce satisfac toate nevoile pe scară rezidențială, comercială sau industrială: tablouri etanșe cu IP 65 (40 CDK de la 2 la 72 module) și IP55; decorative cu IP40, având același grad de protecție și fără șa. sunt disponibile versiuni și cu bară de nul și împământare.



40 CD - IP55



40 CD - TABLOURI
DECORATIVE - IP40



40 CD TABLOURI
FARA USA - IP40



Versiuni din material
fără halogen



Linie de produse
pentru aplicații fotovoltaice
(40 CDK IP65 și 40 CD IP55)



40 CDK - IP65

GAMA 40 CDi

TABLOURI SI COFRETE DE DISTRIBUȚIE MONTATE APARENT

O gama largă, completă: produse pentru orice nevoie

O ofertă bogată de tablouri și cofrete cu montaj îngropat disponibile. 6 linii de produse, incluzând și noile tablouri decorative, dezvoltate să ofere cele mai bune soluții pentru zona rezidențială și terțiară. O gama cu tablouri de la 2 la 72 module (40 CDKi), pentru diferite aplicații, grație gradului de protecție de la IP40 la IP55 (48 PTC) și o versiune dedicată peretilor din gips carton. Sunt disponibile versiuni și cu bară de nul și împământare.



Versiuni din material
fără halogen



40 CDi - TABLOURI
DECORATIVE



40 CDi - CHORUS













40 CDKi - TABLOURI



40 CDi - TABLOURI PENTRU
PERETI DIN GIPS CARTON

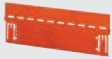



48 PTC - IP55
PENTRU APLICATII SPECIALE

		TABLOURI CU MONTAJ APARENT										
		40 CDK TABLOURI MODULARE SI CUTII DE DISTRIBUTIE ETANSE CU MONTAJ APARENT - IP65		40 CD TABLOURI DE DISTRIBUTIE ETANSE CU MONTAJ APARENT IP55		40 CD TABLOURI MODULARE DE DISTRIBUTIE ETANSE DECORATIVE CU MONTAJ APARENT - IP40		40 CD TABLOURI DE DISTRIBUTIE ETANSE CU MONTAJ APARENT, FARA USA IP40				
		Culoare: RAL 7035 Gri Usa: transparenta fumurie Pereti: netezi 		Culoare: RAL 7035 Gri Usa: transparenta fumurie Pereti: cu predecupari pentru presetupe 		Culoare: RAL 9016 Alb Usa: transparenta fumurie Pereti: netezi 		Culoare: RAL 7035 Gri Usa: fara Pereti: cu predecupari pentru presetupe 				
MODULE	2	-		-		-		GW 40 022				
	4	GW 40 101		GW 40 001		-		GW 40 023				
	6	-		-		-		GW 40 024				
	8	GW 40 102		GW 40 003		GW 40 043		GW 40 026				
	12	GW 40 103		GW 40 005		GW 40 045		GW 40 028				
	12 cu bara nul impamantare	-		GW 40 004		GW 40 044		GW 40 027				
	18	GW 40 106		-		-		-				
	24 (12x2)	GW 40 104		GW 40 007		GW 40 047		GW 40 030				
	24 (12x2) cu bara nul impamantare	-		GW 40 006		GW 40 046		GW 40 029				
	36 (12x3)	GW 40 105		-		-		GW 40 032				
	36 (12x3) cu bara nul impamantare	-		-		-		GW 40 031				
	36 (18x2)	GW 40 107		GW 40 009		GW 40 049		-				
36 (18x2) cu bara nul impamantare	-		GW 40 008		GW 40 048		-					
54 (18x3)	GW 40 108		-		GW 40 051		-					
72 (18x4)	GW 40 109		-		GW 40 053		-					
ACCESORII	INSTALARE	Suporti de fixare aparenta pentru tablouri 	4 x GW 44 621		4 x GW 44 621		4 x GW 44 621		4 x GW 44 621			
		Cadru pentru a acoperi intrarea cu tub 	Module	Cod								
			12-24-36(12x3)	GW 40 473								
	18-36(18x2)-54-72	GW 40 474										
	CABLARE	Bara izolata de nul si impamantare (*) 	Module	Cod	Module	Cod	Module	Cod	Module	Cod		
			8	GW 40 401	8-24	GW 40 401	8-24	GW 40 401	8-24	GW 40 401		
			12-24-36(12x3)	GW 40 402	12-36	GW 40 402	12-36-54-72	GW 40 402	12-36	GW 40 402		
		18-36(18x2)-54-72	GW 40 404									
		Separator intern orizontal 	Module	Cod								
			24-36(12x3)	GW 40 487								
		36(18x2)-54-72	GW 40 488									
		Plastron 	Module	Cod								
			24-36(12x3)	GW 40 492								
	36(18x2)-54-72	GW 40 493										
	ALTE ACCESORII	Cilindru cu chei 	Module	Cod			Module	Cod				
4-8-12-24-36(18x2)			1 x GW 40 422			8-12-18-24-36-54	1 x GW 40 422					
36(12x3)-54-72		2 x GW 40 422			72	2 x GW 40 422						
Cheie triunghiulara 			1 x GW 40 421									

(*) pentru fiecare numar de bare de nul si impamantare ce poate fi instalat in fiecare tablou, gasiti detalii in paginile de catalog.

GAMA 40 CDi

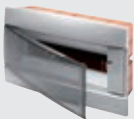
TABLOURI SI COFRETE DE DISTRIBUȚIE MONTATE APARENT

		TABLOURI CU MONTAJ INGROPAT									
		40 CDi TABLOURI ETANSE DECORATIVE IP40				40 CDi TABLOURI CHORUS IP40			40 CDKi TABLOURI MODULARE ETANSE IP40		
											
		Usa: transparenta fumurie				Usa: transparenta fumurie cu deschidere automata			Culoare: RAL 9016 alb Usa: transparenta fumurie sau alba		
		RAMA				RAMA			USA		
		Alb	Negru	Titan	Ardezic	Alb	Titan	Ardezic	Transparenta fumurie	Plina	
MODULE	2	Tablou complet cu doza	-	-	-	-	-	-	-	GW 40 601 (*)	-
	4	Tablou complet cu doza	GW 40 237 TB	GW 40 237 TN	GW 40 237 VT	GW 40 237 VA	-	-	-	GW 40 602	GW 40 882
		Rama tablou si sina DIN	GW 41 237 TB	GW 41 237 TN	GW 41 237 VT	GW 41 237 VA	-	-	-	-	-
	6	Tablou complet cu doza	-	-	-	-	-	-	-	GW 40 603	GW 40 883
	8	Tablou complet cu doza	GW 40 225 TB	GW 40 225 TN	GW 40 225 VT	GW 40 225 VA	-	-	-	GW 40 604	GW 40 884
		Rama tablou si sina DIN	GW 41 225 TB	GW 41 225 TN	GW 41 225 VT	GW 41 225 VA	-	-	-	-	-
	12	Tablou complet cu doza	GW 40 229 TB	GW 40 229 TN	GW 40 229 VT	GW 40 229 VA	GW 40 981 TB	GW 40 981 VT	GW 40 981 VA	GW 40 605	GW 40 885
		Tablou complet cu doza si bara nul-impamantare	GW 40 227 TB	GW 40 227 TN	GW 40 227 VT	GW 40 227 VA	-	-	-	-	-
		Rama tablou si sina DIN	GW 41 229 TB	GW 41 229 TN	GW 41 229 VT	GW 41 229 VA	-	-	-	-	-
	18	Tablou complet cu doza	-	-	-	-	-	-	-	GW 40 608	GW 40 888
	24 (12x2)	Tablou complet cu doza	GW 40 233 TB	GW 40 233 TN	GW 40 233 VT	GW 40 233 VA	GW 40 991 TB	GW 40 991 VT	GW 40 991 VA	GW 40 606	GW 40 886
		Tablou complet cu doza si bara nul-impamantare	GW 40 231 TB	GW 40 231 TN	GW 40 231 VT	GW 40 231 VA	-	-	-	-	-
		Rama tablou si sina DIN	GW 41 233 TB	GW 41 233 TN	GW 41 233 VT	GW 41 233 VA	-	-	-	-	-
	36 (12x3)	Tablou complet cu doza	GW 40 239 TB	GW 40 239 TN	GW 40 239 VT	GW 40 239 VA	-	-	-	-	-
Tablou complet cu doza si bara nul-impamantare		GW 40 241 TB	GW 40 241 TN	GW 40 241 VT	GW 40 241 VA	-	-	-	-	-	
Rama tablou si sina DIN		GW 41 239 TB	GW 41 239 TN	GW 41 239 VT	GW 41 239 VA	-	-	-	-	-	
36 (18x2)	Tablou complet cu doza	-	-	-	-	-	-	-	GW 40 609	GW 40 889	
	Tablou complet cu doza si bara nul-impamantare	-	-	-	-	-	-	-	-	-	
48 (12x4)	Tablou complet cu doza si bara nul-impamantare	-	-	-	-	-	-	-	-	-	
54 (18x3)	Tablou complet cu doza	-	-	-	-	-	-	-	GW 40 610	GW 40 890	
72 (18x4)	Tablou complet cu doza	-	-	-	-	-	-	-	GW 40 611	GW 40 891	
ACCESORII	Suport anti deformare	-				-			GW 40 479 pentru 36M		
	Element cuplare tablouri	2 x GW 40 425 pentru 8M si 12M				-			2 x GW 40 425 pentru 12M		
	Set 4 suruburi lungi cu distantier	GW 48 645 pentru 8M				GW 48 645			GW 48 645 pentru 6M		
	Bara nul-impamantare (**)	Module	Cod			GW 40 402 (1x12M si 2x24M)	Module	Cod			
		8-24	GW 40 401				8	GW 40 401			
		12-36	GW 40 402				12-24	GW 40 402			
							18-36-54-72	GW 40 404			
	Separator intern (orizontal si vertical)	-				-			orizontal	Module	Cod
										24	GW 40 487
										36-54-72	GW 40 488
	Modul de acoperire	-				-			Module	Cod	
									24	GW 40 495	
									36-54-72	GW 40 496	
	Cilindru cu cheie	Module	Cod			-			Module	Cod	
24		1 x GW 40 422						4-6-8-12-18-24-36	1 x GW 40 422		
Doze tablou	36	2 x GW 40 422						54-72	2 x GW 40 422		
	Module	Cod									
	4	GW 40 671									
	8	GW 40 673									
	12	GW 40 674									
	24	GW 40 677									
Module de acoperire	6.5M				4.5M			4.5M			
	GW 40 467 TB (Alb)	GW 40 467 TN (Negru)	GW 40 467 VT (Titan)	GW 40 467 VA (Ardezic)	RAL 9016 Alb	GW 40 467		RAL 9016 Alb GW 40 467			
					RAL 7035 Gri	GW 40 423					
				Negru	GW 40 468						

(*) Fara usa

(**) Pentru fiecare numar de bare de nul si impamantare ce poate fi instalat in fiecare tablou, gasiti detalii in paginile de catalog.

TABLOURI CU MONTAJ INGROPAT

40 CDi TABLOURI ETANSE IP40	48 PTC TABLOURI ETANSE IP55	40 CDi TABLOURI ETANSE PENTRU PERETI DIN GIPS CARTON IP 40	
Culoare: RAL 9016 Alb Usa: alb	Culoare: RAL 7035 Gri Usa: transparenta fumurie	Culoare: RAL 9003 Alb Usa: din metal alba Rama: din metal	
-	-	-	
-	GW 48686 (pentru 2 prize industriale IEC 309)	-	
-	-	-	
-	GW 48 681	-	
GW 40 655	-	-	
-	-	-	
GW 40 657	GW 48 682	-	
GW 40 656	-	GW 40 161	
-	-	-	
-	-	-	
GW 40 659	-	-	
GW 40 658	-	GW 40 162	
-	-	-	
-	-	-	
-	-	GW 40 163	
-	-	-	
GW 40 661	-	-	
GW 40 660	-	-	
-	-	GW 40 164	
-	-	-	
-	-	-	
-	-	-	
-	GW 48 026 (sau mai multe)	-	
GW 48 645	GW 48 645	-	
Module	Cod	Module	Cod
8-24	GW 40 401	12	GW 40 451
12-36	GW 40 402	24	GW 40 452
		36-48	GW 40 453
		Module	Cod
		12	GW 40 460
		24	GW 40 460
		36	GW 40 460
		48	GW 40 460
		Module	Cod
		12	GW 40 456
		24	GW 40 457
		36	GW 40 458
		48	GW 40 459
-	-	-	
1 x GW 40 421 (triunghiular) pentru 12M	1 x GW 48 644 (cilindru metalic etans)	1 x GW 40 463 (cilindru metalic)	
-	-	-	
4.5M	4.5M	4.5M	
RAL 9016 alb - GW 40 467	RAL 7035 gri - GW 40 423	RAL 9016 alb - GW 40 467	

GAMA 42 RV

BUTOANE DE URGENTA CU MONTAJ INGROPAT SAU APARENT

Maxima protectie, siguranta si posibilitati pentru accesorii

5 versiuni diferite pentru butoane de panica pentru a oferi posibilitatea de a alege cea mai buna varianta pentru instalatie, gratie multiplelor tipuri de instalare: cu buton 22, pentru aparate modulare si cu placa de fixare.

Disponibil de asemenea in culoarea rosie sau verde.

Intreaga gama are grad de protectie IP55 si gratie ciocanelului de urgenta, disponibil ca accesoriu si a cilindrilor etans cu cheie, gama este ideala pentru aplicatii in cladiri deschise sau publice.

Referinta GW42201 este echipata pentru manevre voluntare, preventive sau de siguranta intrinseca. Este echipata cu contacte NI si ND si poate fi folosita ca circuit de urgenta semnalizat.



Versiuni din material fara halogen



		Echipat cu buton cu LED	prevazut cu gaura 22mm	Cu sina DIN				Echipata cu placa de fixare	Cu montaj ingropat si sina DIN	
Cod		GW 42 201	GW 42 204	GW 42 206 (4 module)	GW 42 202 (8 module)	GW 42 207 (4 module)	GW 42 208 (8 module)	GW 42 203	GW 42 231 (4 module)	GW 42 232 (4 module)
Culoare		Rosu RAL 3000	Rosu RAL 3000	Rosu RAL 3000	Rosu RAL 3000	Gri RAL 7035	Gri RAL 7035	Rosu RAL 3000	Rosu RAL 3000	Gri RAL 7035
	Ciocan pentru spart geam	GW 42 216								
	Geam inlocuire	GW 42 211	GW 42 213	GW 42 213	GW 42 212	GW 42 213	GW 42 212	GW 42 212	GW 42 214	GW 42 214
	Cilindru etans cu cheie	GW 48 644								
	Contacte	ND	GW 74 201	-	-	-	-	-	-	-
		NI	GW 74 202	-	-	-	-	-	-	-

	LED GW 42 201	Cod	GW 30 951	GW 30 952	GW 30 943	GW 30 945	GW 30 958	GW 30 959	GW 30 960
		Tensiune (V ac/dc)	12	24	230	110	12-24	110-230	48
		Putere (W)	0,4	0,8	0,4	0,8	-	-	-
		Culoare	Alb	Alb	Rosu	Alb	Verde	Verde	Verde

Inovatie de ultima ora

O gama completa de doze etanse de legatura din materiale inovative pentru solutii de ultima ora.

Gama este compusa din trei familii:

- GW PLAST 75 - GWT 650 C pentru aplicatii normale
- GW PLAST 75 - GWT 960 C pentru aplicatii speciale (certificat RINA)
- GW PLAST 120 - GWT 650 C pentru aplicatii industriale.

Marile avantaje ale gamei sunt:

- trei diferite tipuri de materiale din care doua sunt fara halogen si UL94: V0;
- trei grade de protectie: IP44, IP55 si IP56;
- 11 dimensiuni disponibile in 2 versiuni, cu pereti drepti sau cu presetupe;
- 6 tipuri de capace: care se preseaza, fixare cu surub la 1/4, culoare transparenta sau opaca, drept sau inalt;
- noi doze de legatura de mare capacitate, cu pereti drepti, se pot instala tuburi cu diametru pana la 55 mm.



Material GWT 960 C



Certificat RINA



Material fara halogen



pentru solutii fotovoltaice

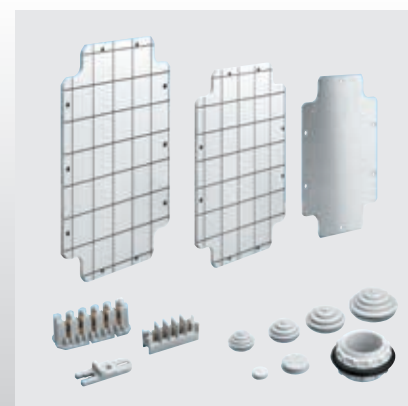
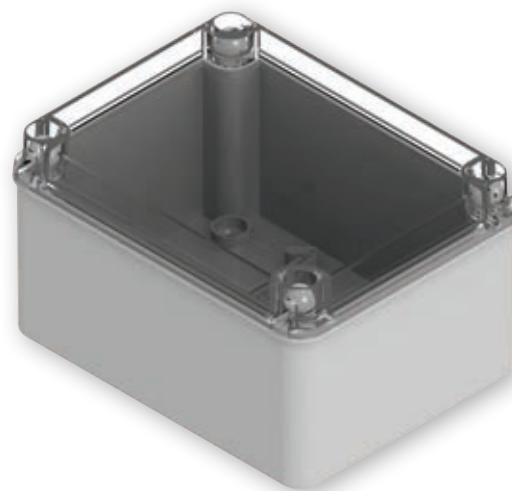
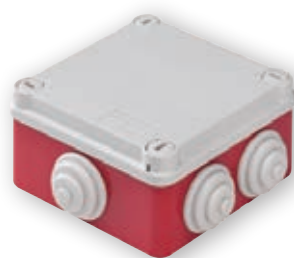

Șuruburi sferice la cap si caneluri in interiorul cutiei

Suruburile la capacul cu dimensiunea 190x140 mm din material izolant sunt folosite si ca garnituri impotriva coruprilor straine si pot folosi si ca balamale (tehnologie patentata). Canelurile din interiorul cutiei faciliteaza instalarea aparatelor, regletelor sau placilor de fixare.

Capac ce ramane prins de doza cu un profil inovativ de ultima ora

Capacul care se inchide la 1/4 poate fi usor manevrat in orice tip de instalatie si unde se poate face usor mentenanta. Suruburile la 1/4 raman de asemenea prinse de capac, fara a cade. Marginea interioara inovativa garanteaza in timp gradul de protectie.

Gama larga de accesorii

O gama larga de accesorii este disponibila: placi de fixare din inos sau material izolant, reglete, suruburi, presetupe.

GAMA 44 CE

DOZE APARENTE ETANSE DE LEGATURA

44 CE - DOZE DE DERIVATIE ETANSE CU MONTAJ APARENT									
Material	Tehnopolymer GW PLAST 75								
Rezistenta la caldura	Termopresiune cu bila: 85°C								
Rezistenta la foc	Testul cu fir incins: 650°C - UL94: HB								
Grad de protectie	IP44	IP55			IP56				
Pereti	cu presetupe	cu presetupe	drepti	drepti					
Adancimea de montare	standard	standard	standard	standard	mare capacitate				
Capac	capac simplu	capac simplu cu suruburi la 1/4	capac simplu	capac simplu cu suruburi la 1/4	capac simplu	capac inalt	capac simplu	capac simplu transparent	
DIMENSIUNI INTERNE LXH (MM)	Dimensiuni (mm)								
	Ø 65	GW 44 001							
	Ø 80	GW 44 002							
	80 x 80	GW 44 003							
	100 x 100		GW 44 024	GW 44 004	GW 44 234	GW 44 204	GW 44 214	GW 44 114	
	120 x 80			GW 44 005		GW 44 205	GW 44 215		
	150 x 110		GW 44 026	GW 44 006	GW 44 236	GW 44 206	GW 44 216		
	190 x 140			GW 44 007		GW 44 207	GW 44 217	GW 44 117	GW 44 137
	240 x 190			GW 44 008		GW 44 208	GW 44 218	GW 44 118	GW 44 138
	300 x 220			GW 44 009		GW 44 209	GW 44 219	GW 44 119	GW 44 139
	380 x 300			GW 44 010		GW 44 210	GW 44 220	GW 44 120	GW 44 140
	460 x 380			GW 44 011		GW 44 211	GW 44 221		

Reliefat: versiuni din material fara halogen.

(*) doze de culoarea rosie, iar capacul este gri.

In rosu: tensiunea izolatiei $U_i=750\text{ V}$ in concordanta cu EN 60670-1 si EN60670-22. Pentru aplicatii fotovoltaice, utilizati suportul de fixare GW44621.

In verde: tensiunea izolatiei $U_i=1000\text{ V}$ in concordanta cu EN 60670-1 si EN60670-22. Pentru aplicatii fotovoltaice, utilizati suportul de fixare GW44621.

44 CE - DOZE DE DERIVATIE ETANSE CU MONTAJ APARENT

Tehnopolymer GW PLAST 75		Tehnopolymer GW PLAST 120							
Termopresiune cu bila: 85°C		Termopresiune cu bila: 110°C							
Testul cu fir incins: 960°C - UL94: V0		Testul cu fir incins: 650°C - UL94: HB							
IP44	IP55	IP56	IP56						
cu presetupe	cu presetupe	drepti	drepti						
standard	standard	standard	standard						
capac simplu	capac simplu cu suruburi la 1/4	capac simplu	capac simplu	capac simplu	capac inalt	capac simplu	capac inalt	capac simplu transparent	capac transparent inalt
GW 44 051 GW 44 051 R (*)									
GW 44 052									
GW 44 053 GW 44 053 R (*)									
	GW 44 054 GW 44 054 R (*)		GW 44 274	GW 44 254	GW 44 404	GW 44 414			
		GW 44 055	GW 44 275	GW 44 255	GW 44 405	GW 44 415			
	GW 44 056 GW 44 056 R (*)		GW 44 276	GW 44 256	GW 44 406	GW 44 416	GW 44 426		GW 44 436
		GW 44 057	GW 44 277	GW 44 257	GW 44 407	GW 44 417	GW 44 427		GW 44 437
		GW 44 058	GW 44 278	GW 44 258	GW 44 408	GW 44 418	GW 44 428		GW 44 438
		GW 44 059	GW 44 279	GW 44 259	GW 44 409	GW 44 419	GW 44 429		GW 44 439
		GW 44 060	GW 44 280	GW 44 260	GW 44 410	GW 44 420	GW 44 430		GW 44 440
		GW 44 061	GW 44 281	GW 44 261	GW 44 411	GW 44 421	GW 44 431		GW 44 441

Mai mult spațiu pentru tuburi, cablare precum și pentru aparate modulare acum

Sistem de doze de legătură și conexiune îngropat și acum este pretabil și pentru aparate modulare pentru a răspunde cerințelor instalațiilor specifice din sectorul rezidențial sau terțiar.

Sistemul se compune din patru familii diferite:

- 48 PT DIN, doze pentru aplicații domotice și de conexiune cu capac protector;
- 48 CM, doze de mare capacitate pentru jonctiune și conexiune cu capac protector - IP40;
- 48 PT, doze de jonctiune și conexiune cu capac protecție mortar - IP40;
- 48 PTC, doze modulare pentru jonctiue, comanda, distribuție cu capac protecție mortar - IP40/IP55.

Gama este completată cu BIG BOX, doze robuste, pentru aparataj modular.



Material fara halogen

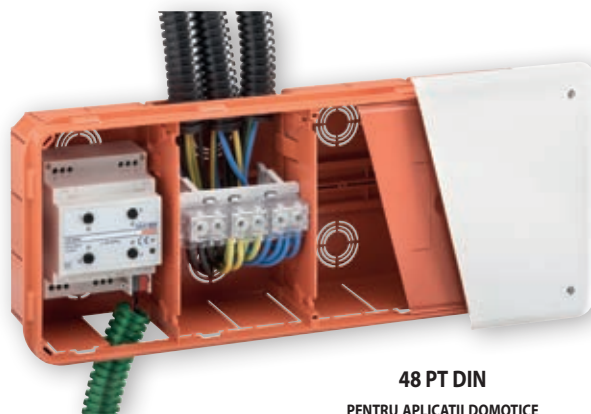

48 PT DIN
PENTRU APLICATII DOMOTICE



48 CM
PENTRU STALPI



48 PT
PENTRU APLICATII NORMALE

















48 PTC
PENTRU APLICATII SPECIALE

BIG BOX



24 SC BIG BOX - DOZE RECTANGULARE PENTRU ZIDARIE		24 SC - BIG BOX ACCESORII			
Cod	Descriere		Cod	Descriere	Pentru BIG BOX Cod
GW 24 403*	3 module		GW 24 403 P	Capac pentru mortar sau zugravit	GW 24 403
GW 24 404	4 module		GW 24 404 P		GW 24 404
GW 24 406	6 module		GW 24 406 P		GW 24 406
GW 24 206	6 module (3+3)		GW 24 321	Perete despartitor	GW 24 403 GW 24 404 GW 24 406
GW 24 237	8 module (4+4)				
GW 24 238	12 module (6+6)		GW 24 330	Element de conexiune	
GW 24 239	18 module (6+6+6)				

48 PT DIN si 48 CM: Capac protectiv din tehnopolymer 48 PT si 48 PTC: Capac protectie mortar inclus			ACCESORII						
			FAMILIA	COD	Dimensiuni (mm)	Nr. de separatoare interne	Element de cuplare	CAPACE DE SCHIMB	
								Capac	Capac inalt
48 PT DIN	GW 48 106		196x152x75	1 x GW 48 012	2 x GW 48 051	IP 40 GW 48 017	IP 40 GW 48 086		
	GW 48 107		294x152x75	2 x GW 48 012	2 x GW 48 051	IP 40 GW 48 018	IP 40 GW 48 087		
	GW 48 108		392x152x75	3 x GW 48 012	2 x GW 48 051	IP 40 GW 48 019	IP 40 GW 48 088		
	GW 48 109		480x160x75	2 x GW 48 012	2 x GW 48 051	IP 40 GW 48 020	-		
	GW 48 110		516x202x90	2 x GW 48 012	2 x GW 48 051	IP 40 GW 48 021	-		
	GW 48 111		516x294x90	5 incluse	2 x GW 48 051	IP 40 GW 48 022	-		
48 CM	GW 48 207		260x260x121	2 incluse	2 incluse	IP 44 GW 48 247	IP 44 GW 48 267		
	GW 48 211		520x260x121	5 incluse	2 incluse	IP 44 GW 48 251	IP 44 GW 48 271		
	GW 48 227		260x260x121	2 incluse	2 incluse	IP 44 GW 48 247	IP 44 GW 48 267		
	GW 48 231		520x260x121	5 incluse	2 incluse	IP 44 GW 48 251	IP 44 GW 48 271		
48 PT	GW 48 001		92x92x45	-	-	IP 40 GW 48 013	-		
	GW 48 002		118x96x50	-	-	IP 40 GW 48 014	-		
	GW 48 003		118x96x70	-	2 x GW 48 051	IP 40 GW 48 014	-		
	GW 48 004		152x98x70	-	2 x GW 48 051	IP 40 GW 48 015	IP 40 GW 48 084		
	GW 48 005		160x130x70	-	2 x GW 48 051	IP 40 GW 48 016	IP 40 GW 48 085		
	GW 48 006		196x152x70	1 x GW 48 012	2 x GW 48 051	IP 40 GW 48 017	IP 40 GW 48 086		
	GW 48 007		294x152x70	2 x GW 48 012	2 x GW 48 051	IP 40 GW 48 018	IP 40 GW 48 087		
	GW 48 008		392x152x70	3 x GW 48 012	2 x GW 48 051	IP 40 GW 48 019	IP 40 GW 48 088		
	GW 48 009		480x160x70	2 x GW 48 012	2 x GW 48 051	IP 40 GW 48 020	-		
	GW 48 010		516x202x80	2 x GW 48 012	2 x GW 48 051	IP 40 GW 48 021	-		
	GW 48 011		516x294x80	5 incluse	2 x GW 48 051	IP 40 GW 48 022	-		
48 PTC - IP40	GW 48 661		138x169x70	-	Reductie pentru cuplarea in serie GW 48 026	GW 48 611	-		
	GW 48 662		308x169x70	1 x GW 48 024		GW 48 612	-		
	GW 48 663		398x169x70	2 x GW 48 024		GW 48 613	-		
48 PTC - IP55	GW 48 671 GW 48 691		138x169x70	-		GW 48 621 GW 48 651	-		
	GW 48 672		308x169x70	1 x GW 48 024		GW 48 622	-		
	GW 48 673		398x169x70	2 x GW 48 024		GW 48 623	-		

			COMPATIBILITATE INTRE BLOCURI TERMINALE SI DOZELE DE LEGATURA												
			44 MM - BLOCURI TERMINALE MULTIPOLARE					44 ME - BLOCURI TERMINALE UNIPOLARE ECHIPOTENTIALE							
			FIXARE PRIN PRESARE	BLOC TERMINAL DE TRECERE				CU PLACA DE STRANGERE INDIRECTA		CU SURUB DE STRANGERE INDIRECT					
															
Tip	Familie	Dimensiuni (mm)	GW 44 606 3x4mm ² GW 44 607 4x4mm ² GW 44 608 5x4mm ²	GW 44 609 3x6mm ² GW 44 610 5x6mm ²	GW 44 611 3x16mm ² GW 44 612 5x16mm ²	GW 44 613 3x35mm ² GW 44 614 5x35mm ²	GW 44 704 4-intrari x 6mm ² GW 44 706 6-intrari x 6mm ²	GW 44 708 8-intrari x 6mm ²	GW 44 671 3-intrari x 6mm ²	GW 44 672 5-intrari x 6mm ²	GW 44 673 4-intrari x 16mm ² GW 44 674 (2x16)+(3x6) mm ²	GW 44 675 (2x16)+(9x6) mm ²	GW 44 676 (2x35)+(4x16) mm ²		
44 CE - DOZE APARENTE ETANSE	IP 44 	Ø65	•				•		•						
		Ø80	•	•			•	•	•	•					
		80 x 80	•	•			•	•	•	•	•				
	IP 55 - IP 56 	100 x 100	•	•	•		•	•	•	•	•	•			
		120 x 80	•	•	•		•	•	•	•	•	•			
		150 x 110		•	•	•	•	•	•	•	•	•	•	•	•
		190 x 140		•	•	•	•	•	•	•	•	•	•	•	•
		240 x 190		•	•	•	•	•	•	•	•	•	•	•	•
		300 x 220		•	•	•	•	•	•	•	•	•	•	•	•
		380 x 300		•	•	•	•	•	•	•	•	•	•	•	•
460 x 380		•	•	•	•	•	•	•	•	•	•	•	•		
48 - DOZE DE LEGATURA CU MONTAJ INGROPAT	48 PT DIN 	196 x 152	•	•	•	•	•	•	•	•	•	•	•	•	
		294 x 152	•	•	•	•	•	•	•	•	•	•	•	•	
		392 x 152	•	•	•	•	•	•	•	•	•	•	•	•	
		480 x 160	•	•	•	•	•	•	•	•	•	•	•	•	
		516 x 202	•	•	•	•	•	•	•	•	•	•	•	•	
		516 x 294	•	•	•	•	•	•	•	•	•	•	•	•	
	48 CM (cu GW 44 682 adaptor) 	260 x 260	•	•	•	•	•	•	•	•	•	•	•	•	
		520 x 260	•	•	•	•	•	•	•	•	•	•	•	•	
		92 x 92	•	•	•	•	•	•	•	•	•	•	•	•	
		118 x 96	•	•	•	•	•	•	•	•	•	•	•	•	
		152 x 98	•	•	•	•	•	•	•	•	•	•	•	•	
		160 x 130	•	•	•	•	•	•	•	•	•	•	•	•	
		48 PT 	196 x 152	•	•	•	•	•	•	•	•	•	•	•	•
			294 x 152	•	•	•	•	•	•	•	•	•	•	•	•
			392 x 152	•	•	•	•	•	•	•	•	•	•	•	•
			480 x 160	•	•	•	•	•	•	•	•	•	•	•	•
	(cu GW 44 682 adaptor)	516 x 202	•	•	•	•	•	•	•	•	•	•	•	•	
		516 x 294	•	•	•	•	•	•	•	•	•	•	•	•	
		PTC (cu adaptor) 	138 x 169	•	•	•	•	•	•	•	•	•	•	•	•
			308 x 169	•	•	•	•	•	•	•	•	•	•	•	•
398 x 169	•		•	•	•	•	•	•	•	•	•	•	•		
48 PTC (cu sina GW 44 683) 	138 x 169						•	•	•	•	•	•	•		
	308 x 169						•	•	•	•	•	•	•		
	398 x 169						•	•	•	•	•	•	•		

• = Potrivit

Nota: blocurile terminale din familia 44 ME cu surub de strangere indirect sunt montate pe placi de fixare sau in partea de jos a dozei folosind adaptorul GW44682. Pentru 48 PTC, se utilizeaza codul GW44683. Pentru familia 44 ME se utilizeaza codul GW44720.

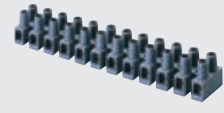
CAPACITATE CONECTARE	44 MS - BLOCURI TERMINALE DE TRECERE SI DE CAPAT				
	BLOC TERMINAL DE CAPAT, TRANSPARENT - IP20		BLOC TERMINAL DE TRECERE, 12 POLI, CULOAREA NEAGRA		
		TIP SURUB - CU FANTA			
2.5mm ²			GW 44 661		GW 44 601
4mm ²			GW 44 665		GW 44 602
6mm ²			GW 44 662		
10mm ²			GW 44 663		GW 44 603
16mm ²			GW 44 664		GW 44 604
25mm ²		TIP SURUB - HEXAGONAL			
35mm ²		GW 44 666		GW 44 605	
		GW 44 667			

Presetupe si accesorii de cuplare

O gama completa de presetupe si accesorii de cuplare pentru tuburi si doze. Presetupe cu pas metric si pas PG (IP68) si pas PG (IP66). Accesorii speciale ca presetupe de cablu intrare de tub rigid, cuplare tub-doza cu grad de protectie ridicat, IP66 si IP44 si presetupe cu un diametru mare. Mai mult, o gama completa de presetupe metalice (IP65 si IP68, complete cu garnitura), capac de inchidere si extensie IP65, piulita de fixare. Toate codurile sunt fabricate din aliaj de nichel cu alama si sunt compatibile cu conectorii si dozele metalice din gama GW Connect.



Accesorii de fixare pentru tuburi si cabluri

Sistemul de fixare Gewiss din plastic si metal a fost extins cu o serie de produse ce pot fi folosite in orice instalatie si poate fi o solutie ideala pentru orice sistem.

Proiectate pentru a simplifica si a creste viteza de prindere si fixare a tuburilor si cablurilor, intreaga familie de accesorii raspunde celor ce vor si au nevoie de sisteme moderne de instalare.

Rapiditatea si siguranta instalarii sunt factori importanti atunci cand alegem fiecare componenta. Pentru a satisface nevoia de instalare rapida, avand un inalt nivel de incredere si siguranta, Gewiss ofera o larga gama de suporturi din plastic si metal cu surub incorporat pentru tuburi si cabluri.



PRESETUPE SI ACCESORII DE CUPLARE

Pas	PRESETUPE DIN PLASTIC								PRESETUPE METALICE				
	IP68		IP66		IP66 pentru intrare tub rigid		IP54		IP68		IP65		
	Cod	Pentru cabluri Ø (mm)	Cod	Pentru cabluri Ø (mm)	Cod	Pentru tuburi Ø (mm)	Pentru cabluri Ø (mm)	Cod	Pentru cabluri Ø (mm)	Cod	Pentru cabluri Ø (mm)	Cod	Pentru cabluri Ø (mm)
PG7	GW 52 071	3 - 6.5	GW 52 001	3 - 6				GW 52 081	4 - 6				
PG9	GW 52 072	4 - 8	GW 52 002	5 - 8				GW 52 082	4.5 - 7				
PG11	GW 52 073	5 - 10	GW 52 003	7 - 10.5				GW 52 083	6 - 9	GW 76 825	4 - 9	GW 76 841	7.5/10/12.5
PG13.5	GW 52 074	6 - 12	GW 52 004	9 - 12.5	GW 52 024	16	9 - 12.5	GW 52 084	9 - 12	GW 76 826	7 - 11	GW 76 842	7.5/10/12.5
PG16	GW 52 075	10 - 14	GW 52 005	13 - 16	GW 52 025	20	13 - 16	GW 52 085	11 - 14	GW 76 827	10 - 13	GW 76 843	7.5/10/12.5
PG21	GW 52 076	13 - 18	GW 52 006	9 - 10 17 - 20	GW 52 026	25	9 - 10 17 - 20	GW 52 086	14 - 18	GW 76 828	12 - 17	GW 76 844	10/13/16/19
PG29	GW 52 077	18 - 25	GW 52 007	13.5 - 15 21 - 26	GW 52 027	32	13.5 - 15 21 - 26	GW 52 087	18 - 25	GW 76 829	17 - 24	GW 76 845	18/21/24/27
PG36	GW 52 078	22 - 32	GW 52 008	17 - 20 30 - 34	GW 52 028	40	17 - 20 30 - 34	GW 52 088	26 - 32	GW 76 830	20 - 26 27 - 24	GW 76 846	24/27/30/33
PG42	GW 52 079	30 - 38	GW 52 009	36 - 39 40 - 43	GW 52 029	50	36 - 39 40 - 43			GW 76 897	32 - 36	GW 76 847	30/33/36/39
PG48	GW 52 080	34 - 44	GW 52 010	38 - 40 46 - 50									
M12	GW 52 042	3 - 6.5								GW 76 894	3 - 6.5		
M16	GW 52 043	5 - 10								GW 76 896	4 - 9		
M20	GW 52 044	10 - 14								GW 76 831	10 - 13	GW 76 848	4/7/10/13
M25	GW 52 045	13 - 18								GW 76 832	12 - 17	GW 76 849	8.5/11.5/14.5/17.5
M32	GW 52 046	18 - 25								GW 76 833	14 - 21	GW 76 850	16/19/22/25
M40	GW 52 047	22 - 32								GW 76 834	19 - 27	GW 76 851	23/26/29/32
M50	GW 52 048	30 - 38								GW 76 835	25 - 34	GW 76 852	30/33/36/39
M63	GW 52 049	35 - 44								GW 76 895	34 - 48		

Pas	ACCESORII DIN PLASTIC			ACCESORII DIN METAL					GARNITURI	
	Capace inchidere	Piulite		Capace de inchidere	Piulite		Extensii			Circulara pentru capace
	Cod	Cod	Cheie piulita (mm)	Cod	Cod	Cheie piulita (mm)	Cod	Filet exterior	Filet interior	Cod
PG7	GW 52 361	GW 52 341	19							GW 52 441
PG9	GW 52 362	GW 52 342	22							GW 52 442
PG11	GW 52 363	GW 52 343	24	GW 76 980	GW 76 957	21	GW 76 865	PG11	PG13.5	GW 52 443
PG13.5	GW 52 364	GW 52 344	27	GW 76 981	GW 76 958	23	GW 76 866	PG13.5	PG16	GW 52 444
PG16	GW 52 365	GW 52 345	30	GW 76 982	GW 76 959	26	GW 76 867	PG16	PG21	GW 52 445
PG21	GW 52 366	GW 52 346	36	GW 76 983	GW 76 960	32	GW 76 868	PG21	PG29	GW 52 446
PG29	GW 52 367	GW 52 347	46	GW 76 984	GW 76 961	41	GW 76 869	PG29	PG36	GW 52 447
PG36	GW 52 368	GW 52 348	60	GW 76 985	GW 76 962	51				GW 52 448
PG42	GW 52 369	GW 52 349	65	GW 76 986	GW 76 963	60				GW 52 449
PG48	GW 52 370	GW 52 350	70							GW 52 450
M12	GW 52 372	GW 52 352	18	GW 76 972	GW 76 966	15				GW 52 452
M16	GW 52 373	GW 52 353	22	GW 76 973	GW 76 951	19				GW 52 453
M20	GW 52 374	GW 52 354	26	GW 76 975	GW 76 952	23	GW 76 870	M20	M25	GW 52 454
M25	GW 52 375	GW 52 355	32	GW 76 976	GW 76 953	29	GW 76 871	M25	M32	GW 52 455
M32	GW 52 376	GW 52 356	41	GW 76 977	GW 76 954	36	GW 76 872	M32	M40	GW 52 456
M40	GW 52 377	GW 52 357	50	GW 76 978	GW 76 955	45	GW 76 873	M40	M50	GW 52 457
M50	GW 52 378	GW 52 358	60	GW 76 979	GW 76 956	55				GW 52 458
M63	GW 52 379	GW 52 359	75	GW 76 974	GW 76 967	70				GW 52 459

ACCESORII DE CUPLARE PENTRU TUBURI SI CABLURI

Pentru tuburi/ cabluri (mm)	Cuplare tub-doza				Cuplare tub-doza din polymer flexibil IP44		Presetupe din polymer flexibil IP55	
	Cod	Diametru gaura (mm)	IP cu tub rigid	IP cu tub flexibil	Cod	Diametru gaura (mm)	Cod	Diametru gaura (mm)
16	GW50415	20	IP66	IP54	GW50421	23	GW50428	19
20	GW50416	23	IP66	IP54	GW50422	23	GW50429	23
					GW50423	29		
25	GW50417	29	IP66	IP54	GW50424	29	GW50430	29
32	GW50418	37	IP66	IP54	GW50425	37	GW50431	37
40	GW50419	48	IP66	IP44	GW50426	37	GW50432	48
50	GW50420	54	IP66	IP44	GW50427	42		

ACCESORII DE FIXARE PENTRU TUBURI SI CABLURI

ACCESORII DE FIXARE DIN PLASTIC

Diametru tuburi (mm)	Suport cu clic	Suport colier	Sina pentru suporturi clic sau colier	Suport colier cu fixare automata	Sina pentru suport colier cu fixare automata	Suport cu clema multidiametru
16	GW 50 601	GW 50 605	GW 50 609	GW 50 641	GW 50 645	GW 50 651
20	GW 50 602	GW 50 606	GW 50 609	GW 50 642	GW 50 645	GW 50 651
25	GW 50 603	GW 50 607	GW 50 609	GW 50 642 GW 50 643	GW 50 645	GW 50 652
32	GW 50 604	GW 50 608	GW 50 609	GW 50 643	GW 50 645	GW 50 652
40	GW 50 628	GW 50 630	GW 50 609	GW 50 644	GW 50 645	GW 50 653
50	GW 50 629	GW 50 631	GW 50 609			GW 50 653

ACCESORII DE FIXARE DIN PLASTIC

Diametru tuburi (mm)	Suport colier cu re-deschidere	Suport colier		Surub de perete		Capsa simpla	Capsa dubla prindere
				dimensiune Ø 6mm	capsa prindere Ø 8mm		
16	DX 51 120	DX 51 232		DX 51 306	DX 51 308	GW 50 671	GW 50 681
20	DX 51 120	DX 51 232		DX 51 306	DX 51 308	GW 50 672	GW 50 682
25		DX 51 232	DX 51 263	DX 51 306	DX 51 308	GW 50 673	GW 50 683
32		DX 51 232	DX 51 263	DX 51 306	DX 51 308		
40			DX 51 263	DX 51 306	DX 51 308		
60			DX 51 263	DX 51 306	DX 51 308		
63			DX 51 263	DX 51 306	DX 51 308		

ACCESORII DE FIXARE CU SURUB INCORPORAT

Diametru tuburi (mm)	Suport clic cu surub incorporat		Suport colier cu surub inclus - nivel ridicat de fixare		Dublu suport colier cu surub inclus - nivel ridicat de fixare		Capsa simpla cu surub incorporat inclus		Capsa dubla cu surub incorporat inclus	
	Cod	diametru surub (mm)	Cod	diametru surub (mm)	Cod	diametru surub (mm)	Cod	diametru surub (mm)	Cod	diametru surub (mm)
16	GW 50 706	6	GW 50 716	6	GW 50 726	8	GW 50 776	8	GW 50 786	8
20	GW 50 707	6	GW 50 717	8	GW 50 727	10	GW 50 777	8	GW 50 787	8
25	GW 50 708	6	GW 50 718	10	GW 50 728	10	GW 50 778	8	GW 50 788	8
32	GW 50 709	8								

ACCESORII DE FIXARE DIN METAL

Diametru cabluri/ tuburi (mm)	Suport colier cu 2 suruburi		Suport colier cu 2 suruburi si surub de fixare incorporat		Capsa simpla de prindere	Capsa dubla de prindere
	Cod	diametru surub (mm)	Cod	diametru surub (mm)		
10-11	GW 50 801				GW 50 811	GW 50 821
12-13	GW 50 802				GW 50 812	GW 50 822
14-15	GW 50 803				GW 50 813	GW 50 823
16-17	GW 50 804		GW 50 841	6	GW 50 814	GW 50 824
19-20	GW 50 805		GW 50 842	6	GW 50 815	GW 50 825
21-22	GW 50 806				GW 50 816	GW 50 826
25-26	GW 50 807		GW 50 843	8	GW 50 817	GW 50 827
31-32	GW 50 808		GW 50 844	8	GW 50 818	GW 50 828
38-40	GW 50 809		GW 50 845	8	GW 50 819	GW 50 829
48-50	GW 50 810		GW 50 846	8	GW 50 820	GW 50 830

ACCESORII DE FIXARE PENTRU CABLURI

Diametru cabluri (mm)	Capse cu cui		Latimea cablurilor drepte (mm)	Capse cu cui pentru cabluri drepte	Clema fixare cabluri	Clema dubla fixare cabluri
	Cod	diametru (mm)				
3-4	GW 50 610				GW 50 691 pentru instalarea a 8 cabluri (3x1.5)	GW 50 692 pentru instalarea a 2x8 cabluri (3x1.5)
5-6	GW 50 611 GW 50 621*		5-6	GW 50 623		
7-8	GW 50 612 GW 50 622*		7-8	GW 50 624		
9-10	GW 50 613		10-11	GW 50 625		
11-12	GW 50 614					
13-14	GW 50 615					
15-16	GW 50 616					
19-20	GW 50 617					
21-22	GW 50 618					
25-26	GW 50 619					
31-32	GW 50 620					

* Culoare: alb

SUPPORTURI SI ACCESORII DE FIXARE PENTRU TUBURI/CABLURI

Diametru cabluri/ tuburi (mm)	Suport colier de perete		Suport colier de perete	
	Cod	diametru (mm)	Cod	diametru (mm)
3-13	GW 50 666	6		
8-26			GW 50 667	6

BENZI DE FIXARE

Banda de montaj metalica - 10 m	Banda de montaj din tesatura - 10 m	Unealta pentru fixare	Cui otel, 18 mm lungime
GW 50 791	GW 50 792	GW 50 798	GW 50 799

Micile detalii pot avea un mare impact in siguranta

O gama de coliere completa si utilizata in aplicatii profesionale. Aceste produse isi gasesc aplicabilitatea in tablouri, cutii de jonctiune si de asemenea in alte aplicatii universale. Desi fac legaturi simple, sunt elemente cheie pentru siguranta operationala a sistemelor electrice. Oferta este compusa din 6 familii diferite, in versiuni pentru cablare (PA 66) si L.T.R. (PA12) cu cu dublu cap pentru aplicatii exterioare, garantand sigilarea chiar cand avem conditii de mediu greu. Inalta performanta a colierelor din PA12, un foarte apreciat material ce este caracterizat printr-o mica capacitate higroscopica, in special pentru zone exterioare, cand sunt temperaturi scazute. Aceste coliere cu dimensiuni 9x265 mm si mai mari au dublu cap. gama este completata cu accesorii speciale de fixare.



Material fara halogen



COLIERE							COLIERE DE EXTERIOR		
Dimensiuni LxH (mm)	Capacitatea de strangere Ø (mm)	STANDARD	MEDIU GREU	CU RE-DESCHIDERE	CU OCHI	CU ETICHETA	Dimensiuni LxH (mm)	Capacitatea de strangere Ø (mm)	COLIERE L.T.R.
2.4x75	1.5 - 18	GW 52 231	GW 52 251	-	-	-	6 x 115	5 - 25	GW 52 201
2.5x96	1.5 - 23	GW 52 232	GW 52 252	-	-	-	6 x 180	9 - 45	GW 52 202
2.5x100	1.5 - 25	-	-	-	GW 52 281	-	6 x 290	20 - 78	GW 52 203
2.5x100	5 - 25	-	-	-	-	GW 52 291	9 x 180	10 - 40	GW 52 204
2.5x110	1.5 - 25	-	-	-	-	GW 52 292	9 x 265	26 - 60	GW 52 205
2.5x140	1.5 - 35	GW 52 233	GW 52 253	-	-	-	9 x 360	26 - 93	GW 52 206
2.5x200	10 - 50	-	-	-	-	GW 52 293	9 x 510	70 - 140	GW 52 207
2.5x203	1.5 - 55	GW 52 234	GW 52 254	-	-	-	9 x 760	70 - 220	GW 52 208
3.6x150	2.5 - 39	GW 52 235	GW 52 255	-	-	-			
3.6x203	2.5 - 55	GW 52 236	GW 52 256	-	-	-			
3.6x292	2.5 - 85	GW 52 237	GW 52 257	-	-	-			
4.2x205	2.5 - 60	-	-	-	GW 52 282	-			
4.6x200	10 - 50	-	-	-	-	GW 52 294			
4.8x190	3 - 52	GW 52 238	GW 52 258	-	-	-			
4.8x280	3 - 81	GW 52 239	GW 52 259	-	-	-			
4.8x368	3 - 182	GW 52 240	GW 52 260	-	-	-			
7.6x100	4 - 35	-	-	GW 52 271	-	-			
7.6x200	4 - 50	-	-	GW 52 272	-	-			
7.6x300	4 - 80	-	-	GW 52 273	-	-			
7.6x380	4 - 110	GW 52 241	GW 52 261	-	-	-			
9.0x610	5 - 185	GW 52 242	GW 52 262	-	-	-			
9.0x914	5 - 270	GW 52 243	GW 52 263	-	-	-			

Tuburi rigide

Tuburile rigide si accesoriile Gewiss permit sistemelor articulate sa fie implementate in conditii de maxima siguranta in orice mediu si pentru orice tip de instalatie.

Gama cuprinde 4 tipuri de tuburi, fiecare dintre ele fiind in concordanta cu standardele EN 61386-1 si EN 61386-21:

RK15: 3321 Clasificare pentru aplicatii standard;

IRL/B: 3321 Clasificare pentru aplicatii standard;

RKB: 4321 Clasificare pentru aplicatii in mediu greu;

RKHF: 4422 Clasificare pentru mediu greu ce necesita maxima siguranta pentru oameni (material fara halogen).



Accesorii

O gama larga de elemente de cuplare, racorduri si componente de traseu pentru punerea in aplicare a unor sisteme articulate. Posibilitatea de a obtine doua grade de protectie: IP40 si IP67.



Material fara halogen

Familia RKHF de tuburi si accesorii, din material fara halogen: solutia ideala pentru instalatiile cu afluenta mare de public si medii aglomerate gratie emisiilor scazute de toxicitate in caz de incendiu.



Doze TRIX si QUADRIX

Fixarea dozelor cu accesoriile adecvate asigura o perfecta etanseitate gratie garniturii rotunde. Capacul dozei se instaleaza prin presare asigurand o rapida implementare si simplitate in inspectia sistemului.

DIAMETRU TUB	TUBURI RIGIDE						RK - COMPONENTE DE TRASEU			
	IRL/B		RK 15		RKB	RKHF	Mufa IP40	Cot IP40	Imbinare in T IP40	Cot IP40
16	DX 27 616	DX 27 716	DX 25 216	DX 25 316	DX 25 716	DX 26 216	DX 40 016	DX 40 116	DX 40 216	DX 40 316
20	DX 27 620	DX 27 720	DX 25 220	DX 25 320	DX 25 720	DX 26 220	DX 40 020	DX 40 120	DX 40 220	DX 40 320
25	DX 27 625	DX 27 725	DX 25 225	DX 25 325	DX 25 725	DX 26 225	DX 40 025	DX 40 125	DX 40 225	DX 40 325
32	DX 27 632	DX 27 732	DX 25 232	DX 25 332	DX 25 732	DX 26 232	DX 40 032	DX 40 132	DX 40 232	DX 40 332
40		DX 27 740		DX 25 340	DX 25 740	DX 26 240	DX 40 040	DX 40 140		
50		DX 27 750		DX 25 350	DX 25 750	DX 26 250	DX 40 050	DX 40 150		
63		DX 27 763		DX 25 363	DX 25 763	DX 26 263	DX 40 063	DX 40 163		

Diametru	MORBIDX - COMPONENTE DE TRASEU										
	Manson Ip67	Cot cu unghi strans - IP67	Range conduit-box pipe-fitting - IP67		Racord tub-manta IP65		Racord tub-manta IP65		Racord tub-cablu IP65		SPEEDY-FLEX racorduri flexibile
			Pas metric		Manson Ø		Manson Ø		Diametru cablu		IP44
16	DX 43 016	DX 43 116	M16x1,5	DX 43 216	12	DX 43 316	16	DX 43 416			GW 50 207
20	DX 43 020	DX 43 120	M20x1,5	DX 43 220	16	DX 43 320	20	DX 43 420	3-6 6-9 9-12	DX 43 713 DX 43 716 DX 43 719	GW 50 208
25	DX 43 025	DX 43 125	M25x1,5	DX 43 225	20	DX 43 325	25	DX 43 425			GW 50 209
32	DX 43 032	DX 43 132	M32x1,5	DX 43 232	25	DX 43 332	28	DX 43 432			GW 50 210
40	DX 43 040	DX 43 140	M40x1,5	DX 43 240	32	DX 43 340	40	DX 43 440			GW 50 211
50	DX 43 050	DX 43 150	M50x1,5	DX 43 250	40	DX 43 350					GW 50 212

DESCRIERE	DOZE		RACORDURI PENTRU DOZELE TRIX SI QUADRIX - IP54									
		Capac inchidere	Racord doza-doza	Racord doza-tub			Racord doza - tub spiralat			Racord doza-cablu		
				Diametru tub 16	Diametru tub 20	Diametru tub 25	Diametru manson 12	Diametru manson 16	Diametru manson 20	Diametru cabluri 3-6	Diametru cabluri 6-9	Diametru cabluri 9-12
3-intrari TRIX BOX	DX 45 003	DX 47 000	DX 47 001	DX 47 616	DX 47 620	DX 47 625	DX 47 212	DX 47 216	DX 47 220	DX 47 503	DX 47 506	DX 47 509
4-intrari QUADRIX BOX	DX 45 004	DX 47 000	DX 47 001	DX 47 616	DX 47 620	DX 47 625	DX 47 212	DX 47 216	DX 47 220	DX 47 503	DX 47 506	DX 47 509
7-intrari QUADRIX BOX	DX 45 007	DX 47 000	DX 47 001	DX 47 616	DX 47 620	DX 47 625	DX 47 212	DX 47 216	DX 47 220	DX 47 503	DX 47 506	DX 47 509
10-intrari QUADRIX BOX	DX 45 010	DX 47 000	DX 47 001	DX 47 616	DX 47 620	DX 47 625	DX 47 212	DX 47 216	DX 47 220	DX 47 503	DX 47 506	DX 47 509

■ = material fara halogen in concordanta cu EN 50267-2-2

Tuburi flexibile FK15, ICTA si FKHF

FK15: tuburi flexibile cu rezistenta medie clasa 3321, diametru de la 16 la 63 mm, in sase culori diferite - disponibile atat cu fir de tragere sau fara - pentru a identifica curentii intr-o instalatie.

ICTA - tuburi flexibile cu rezistenta medie clasa 3422 si FKHF - tuburi flexibile fara halogen conform cu standardul EN 50267-2-2 sunt ideale pentru instalatii pentru cladiri publice: datorita faptului ca sunt fabricate fara halogen, in caz de incendiu, emisiile toxice sunt foarte reduse.

FK 15, ICTA si FKHF sunt in concordanta cu standardele EN 61386-1 si EN 61386-22.



Material
fara halogen

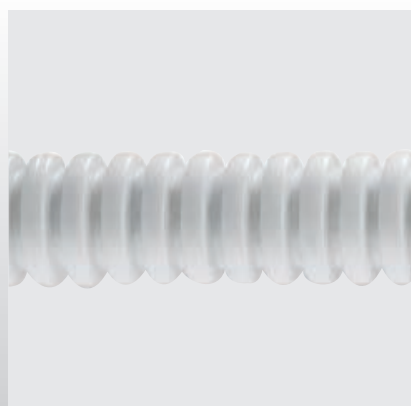

Flexibilitate

Profilul tuburilor flexibile FK15 este caracterizat de o geometrie speciala a cercurilor, oferind o mare flexibilitate, rezistenta marita in sarcina si reduce memoria termica ce simplifica si mareste viteza caii de rulare in interior a conductorului.

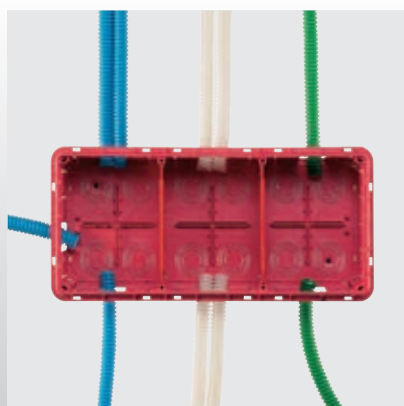

Trasee identificabile

FK15 are o varietate de culori pentru a asigura solutii pentru instalatii electrice moderne, unde identificarea liniilor este esentiala.



Permormanta inalta

Tuburile flexibile ICTA sunt recomandate pentru a fi utilizate sub podea si in beton. De fapt, tuburile flexibile ICTA nu necesita vreo protectie mecanica in timpul turnarii. Sunt foarte bune de instalat cand avem sape lichide.

DIAMETRU	FK15 - TUBURI FLEXIBILE - CLASA 3321											
	Alb		Negru		Verde		Albastru		Maron		Liliac	
		cu fir de tragere		cu fir de tragere		cu fir de tragere		cu fir de tragere		cu fir de tragere		cu fir de tragere
16	DX 16 216	DX 16 316	DX 15 016	DX 15 116	DX 15 216	DX 15 316	DX 15 416	DX 15 516	DX 15 616	DX 15 716	DX 15 816	DX 15 916
20	DX 16 220	DX 16 320	DX 15 020	DX 15 120	DX 15 220	DX 15 320	DX 15 420	DX 15 520	DX 15 620	DX 15 720	DX 15 820	DX 15 920
25	DX 16 225	DX 16 325	DX 15 025	DX 15 125	DX 15 225	DX 15 325	DX 15 425	DX 15 525	DX 15 625	DX 15 725	DX 15 825	DX 15 925
32	DX 16 232	DX 16 332	DX 15 032	DX 15 132	DX 15 232	DX 15 332	DX 15 432	DX 15 532	DX 15 632	DX 15 732	DX 15 832	DX 15 932
40	DX 16 240	DX 16 340	DX 15 040	DX 15 140	DX 15 240		DX 15 440		DX 15 640		DX 15 840	
50	DX 16 250	DX 16 350	DX 15 050	DX 15 150	DX 15 250		DX 15 450		DX 15 650		DX 15 850	
63	DX 16 263	DX 16 363	DX 15 063	DX 15 163								

DIAMETRU	ICTA - TUBURI FLEXIBILE CU REVENIRE, FARA HALOGEN - CLASA 3422								FKHF - TUBURI FLEXIBILE CU REVENIRE, FARA HALOGEN - CLASA 2322	
	Gri		Gri inchis		Verde		Albastru		Gri	
		cu fir de tragere		cu fir de tragere		cu fir de tragere		cu fir de tragere		cu fir de tragere
16	DX 20 016	DX 20 116	DX 20 416	DX 20 516	DX 22 016	DX 22 116	DX 23 016	DX 23 116	DX 23 216	DX 23 316
20	DX 20 020	DX 20 120	DX 20 420	DX 20 520	DX 22 020	DX 22 120	DX 23 020	DX 23 120	DX 23 220	DX 23 320
25	DX 20 025	DX 20 125	DX 20 425	DX 20 525	DX 22 025	DX 22 125	DX 23 025	DX 23 125	DX 23 225	DX 23 325
32	DX 20 032	DX 20 132	DX 20 432	DX 20 532	DX 22 032	DX 22 132	DX 23 032	DX 23 132	DX 23 232	DX 23 332
40	DX 20 040	DX 20 140	DX 20 440	DX 20 540	DX 22 040	DX 22 140	DX 23 040	DX 23 140	DX 23 240	DX 23 340
50	DX 20 050	DX 20 150	DX 20 450	DX 20 550	DX 22 050	DX 22 150	DX 23 050	DX 23 150	DX 23 250	DX 23 350
63	DX 20 063	DX 20 163	DX 20 463	DX 20 563	DX 22 063	DX 22 163	DX 23 063	DX 23 163	DX 23 263	DX 23 363

ACCESORII PENTRU TUBURI FLEXIBILE			
DIAMETRU			
	Mufa GF	Capac TF	Presetupa tub/doza
16	DX 52 016	DX 52 116	GW 50 415
20	DX 52 020	DX 52 120	GW 50 416
25	DX 52 025	DX 52 125	GW 50 417
32	DX 52 032	DX 52 132	GW 50 418
40	DX 52 040	DX 52 140	GW 50 419
50	DX 52 050	DX 52 150	GW 50 420
63	DX 52 063	DX 52 163	

FIR DE TRAGERE				
Lungime (m)				
	Diametru fir de tragere 3 mm	Diametru fir de tragere 4 mm		
	ST	STS	Cap flexibil	Inel
5	DX 52 205	DX 52 305	DX 52 299	DX 52 399
10	DX 52 210	DX 52 310	DX 52 299	DX 52 399
15	DX 52 215	DX 52 315	DX 52 299	DX 52 399
20	DX 52 220	DX 52 320	DX 52 299	DX 52 399
25	DX 52 225	DX 52 325	DX 52 299	DX 52 399

Tuburi spiralate



DF: tuburi spiralate clasa 2311, 14 diametre, de la 8 la 60 mm, in trei culori, gri, negru si albastru. Pentru diametrele de 12, 16, 20, 25 mm sunt disponibile si in clasa 1311 pentru alicatii de curenti slabi.

Tuburile si accesoriile cu grad de protectie IP54, culori gri sau negru, cu pas metric, PG si GAS sunt disponibile pentru a face conexiunea intre tablouri, doze si tuburi rigide: adecvat pentru a integra toti consumatorii din toate mediile.

Gratie flexibilitatii si rezistentei, DF este o solutie castigatoare pentru iesirea, conectarea la tuburile rigide si alimentarea catre diferiti consumatori mecanici.

DF este in concordanta cu standardele EN 61386-1 si EN 61386-23.



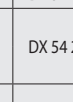
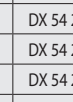
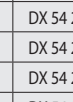

DIAMETRU Ø (mm)	TUBURI SPIRALATE				RACORDURI ROTATIVE - IP54								
	DIFLEX - clasa 2311			LIGHT clasa 1311	RDM		RDG		RDPG				
	Gri	Negru	Albastru	Gri		Gri	Negru		Gri	Negru		Gri	Negru
8	DX 30 008	DX 30 108			pas metric			pas GAS			Pas PG		
					M12x1	DX 54 008	DX 54 108	1/4"	DX 54 208	DX 54 308	7	DX 54 408	DX 54 508
10	DX 30 010	DX 30 110			M16x1.5	DX 54 010	DX 54 110	1/4"	DX 54 210	DX 54 310	7 9	DX 54 410 DX 54 411	DX 54 510 DX 54 511
12	DX 30 012	DX 30 112	DX 30 212	DX 30 812	M16x1.5	DX 54 012	DX 54 112	3/8"	DX 54 212	DX 54 312	11 13,5	DX 54 412 DX 54 413	DX 54 512 DX 54 513
14	DX 30 014	DX 30 114						1/2"	DX 54 214	DX 54 314	13,5	DX 54 414	DX 54 514
16	DX 30 016	DX 30 116	DX 30 216	DX 30 816	M20x1.5	DX 54 016	DX 54 116	1/2"	DX 54 216	DX 54 316	13,5 16	DX 54 416 DX 54 417	DX 54 516 DX 54 517
20	DX 30 020	DX 30 120	DX 30 220	DX 30 820	M25x1.5	DX 54 020	DX 54 120	3/4"	DX 54 220	DX 54 320	21	DX 54 420	DX 54 520
22	DX 30 022	DX 30 122	DX 30 222		M25x1.5	DX 54 022	DX 54 122	3/4"	DX 54 222	DX 54 322	21	DX 54 422	DX 54 522
25	DX 30 025	DX 30 125	DX 30 225	DX 30 825	M32x1.5	DX 54 025	DX 54 125	1"	DX 54 225	DX 54 325	29	DX 54 425	DX 54 525
28	DX 30 028	DX 30 128			M32x1.5	DX 54 028	DX 54 128	1"	DX 54 228	DX 54 328	29	DX 54 428	DX 54 528
32	DX 30 032	DX 30 132	DX 30 232		M40x1.5	DX 54 032	DX 54 132	1 1/4"	DX 54 232	DX 54 332	36	DX 54 432	DX 54 532
35	DX 30 035	DX 30 135						1 1/4"	DX 54 235	DX 54 335	36	DX 54 435	DX 54 535
40	DX 30 040	DX 30 140	DX 30 240		M50x1.5	DX 54 040	DX 54 140	1 1/2"	DX 54 240	DX 54 340			
50	DX 30 050	DX 30 150			M63x1.5	DX 54 050	DX 54 150	2"	DX 54 250	DX 54 350			
60	DX 30 060	DX 30 160											

Sisteme de acces: versatilitate si convenienta

Disponibile in 4 dimensiuni - de la 200 la 550 mm - cu rezistenta marita si capac cu gratar, ideale pentru sisteme electrice sau aplicatii in telecomunicatii. Sunt potrivite, in particular, pentru iluminata public sau pentru legarea la pamant. Datorita materialelor termoplastice, baza este pre-decupata si ofera posibilitatea de suprapunere, gama PZ este o alternativa la dozele pentru beton, asigurand o rezistenta optima si performanta pe termen lung.



CAMINE DE ACCES DIN TERMOPLASTIC



Tip	Dimensiuni (mm)	Camine cu capac	Camine fara capac	Capace						Separator	Garnitura	Set 4 suruburi	Surub
				Pline			Cu gratar						
				Gri	Verde	Albastru	Gri	Verde	Albastru				
Camine patrate 	200x200x200	DX 59 401	DX 59 402	DX 59 410	DX 59 430		DX 59 411	DX 59 431		DX 59 440	DX 59 451	DX 59 450	
	300x300x300	DX 59 701	DX 59 702	DX 59 710	DX 59 730		DX 59 711	DX 59 731		DX 59 740	DX 59 751	DX 59 450	
	400x400x400	DX 59 801	DX 59 802	DX 59 810	DX 59 830		DX 59 811	DX 59 831		DX 59 840	DX 59 851	DX 59 452	DX 59 453
	550x550x520	DX 59 901	DX 59 902	DX 59 910	DX 59 930		DX 59 911	DX 59 931		DX 59 940	DX 59 951	DX 59 452	DX 59 453
Set 8 camine complete cu capac 	200x200x200	DX 59 460		DX 59 410	DX 59 430		DX 59 411	DX 59 431			DX 59 451	DX 59 450	
	300x300x300	DX 59 760		DX 59 710	DX 59 730		DX 59 711	DX 59 731			DX 59 751	DX 59 450	
Camine rectangulare 	360x260x326	DX 59 501	DX 59 502	DX 59 511	DX 59 230	DX 59 220	DX 59 520	DX 59 231	DX 59 221	Transversal DX 59 240 Longitudinal DX 59 241 Diagonal DX 59 242	DX 59 551	DX 59 650	

Tuburi gofrate: flexibilitate in utilizare

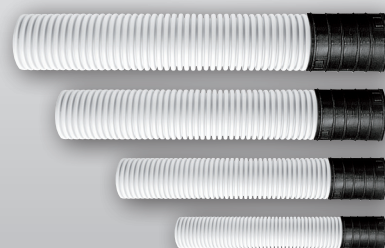
Forma speciala cu pereti dubli, fabricat din PEHD si disponibil in 10 dimensiuni cu diametru de la 40 la 200 mm, avand fir de tragere, permite raze înguste de curbură, poate fi montat in zone de excavatie imperfecte.



TUB GOFRAT CU PERETI DUBLI

Diametru (mm)	40	50	63	75	90	110	125	160	200
Tub gofrat 	DX 35 000	DX 35 001	DX 35 002	DX 35 003	DX 35 004	DX 35 005	DX 35 006	DX 35 008	DX 35 009
Cuple 	DX 58 200	DX 58 201	DX 58 202	DX 58 203	DX 58 204	DX 58 205	DX 58 206	DX 58 208	DX 58 209

Jgheaburi metalice BFR si BRN

BFR Jgheaburi metalice tip plasa:

o alternativa ce este mult mai functionala, simpla si cost eficient fata de traditionalele trasee de jgheaburi metalice. Disponibile in 30, 60 si 110 mm inaltime, latime de la 50 la 600 mm si 5 finisaje, inclusiv noul finisaj HP (protectie ridicata) ideal pentru mediu exterior. Suporturile de sustinere, de jonctiune automata si absenta componentelor de traseu asigura o simpla si rapida instalare cu putine coduri.

BRN Jgheaburi metalice tip tabla perforata:

disponibile in 4 dimensiuni pe inaltime - de la 35 la 80 mm - 12 dimensiuni pe latime, de la 95 la 605 mm si 3 finisaje, asigurand instalarea in toate tipurile de instalatii, de la mici pana la instalatii in mediu greu. Familia BRN este caracterizata de ranforsarile pe care le prezinta pentru a avea rezistenta la sarcini.



SP - suporturi fixe



Suporturi Omega: sarcini usoare

Suporturile pot fi instalate pe montant sau montate la suprafata. De forma literei C, pot fi montate de tavan fara a utiliza montanti. Disponibile in finisajele Z275, GAC si otel inox.



Suporturi C40 Pluriel: sarcini medii

Suporturile sunt instalate pe un profil. Fixarea se poate face in multe configuratii fara a folosi alte accesorii din metal. Disponibile in finisaj Z275 si otel inox la cerere.



Suporturi Mavistrut: sarcini grele

Suporturile sunt instalate pe un profil. Fixarea e simpla, fara a utiliza alte accesorii metalice. Disponibile in finisaj Z275 si GAC.

PENTRU SARCINI USOARE

	GAMA OMEGA					UN SINGUR ELEMENT (CUPLA+MONTANT+SUPPORT)	GAMA OMEGA "C"					
	Descriere	Lungime (mm)	Z 275	GAC	OTEL INOX		Descriere	Inaltime (mm)	Standard (mm)	Z 275	GAC	OTEL INOX
SUPPORT CU FIXARE PETAVAN	Omega	410	MV 62 100	MV 62 200	MV 62 600		Omega "C"	115	95	MV 62 110	MV 62 210	MV 62 610
		510	MV 62 101	MV 62 201	MV 62 601				195	MV 62 111	MV 62 211	MV 62 611
		610	MV 62 102	MV 62 202	MV 62 602				265	MV 62 112	MV 62 212	MV 62 612
SUPORTI		110	MV 60 100	MV 60 200	MV 60 600			215	95	MV 62 113	MV 62 213	MV 62 613
		210	MV 60 101	MV 60 201	MV 60 601				195	MV 62 114	MV 62 214	MV 62 614
		310	MV 60 102	MV 60 202	MV 60 602				265	MV 62 115	MV 62 215	MV 62 615
		410	MV 60 113	MV 60 213	MV 60 613		265	95	MV 62 116	MV 62 216	MV 62 616	
		510	MV 60 114	MV 60 214	MV 60 614			195	MV 62 117	MV 62 217	MV 62 617	
		610	MV 60 115	MV 60 215	MV 60 615			265	MV 62 118	MV 62 218	MV 62 618	
ACCESORII	"FILMATIC" BFR prindere rapida		Z275 finisaj: MV 51 100 HP finisaj: MV 51 700 INOX finisaj: MV 51 800									
	Contrapiulita de fixare / suport Omega	BICHRO	MV 64 401									
	Distanțier pentru asamblare suporti Omega pe profile Mavistrut		MV 64 105									
	Surub	M10 X 30 M10 X 60	BICHRO MV 66 122 MV 66 123	DACHO MV 66 222 MV 66 223	Otel inox MV 66 622 MV 66 623							

PENTRU SARCINI GRELE

	MAVISTRUT			
	Descriere	Lungime (mm)	EZ	GAC
SUPPORT DETAVAN		simplicu 400	MV 81 403	MV 81 203
		dublu 400	MV 81 453	MV 81 253
		simplicu 640	MV 81 406	MV 81 206
		dublu 640	MV 81 456	MV 81 256
		simplicu 560	MV 81 415	MV 81 215
		dublu 560	MV 81 465	MV 81 265
		simplicu 800	MV 81 418	MV 81 218
		dublu 800	MV 81 468	MV 81 268
		simplicu 1040	MV 81 421	MV 81 221
		dublu 1040	MV 81 471	MV 81 271
		simplicu 1520	MV 81 427	MV 81 227
		dublu 1520	MV 81 477	MV 81 277
	simplicu 41 x 41		MV 64 240	
	contra placa		MV 64 241	
	bolted 41 x 29		MV 64 230	
MONTANT		41 x 29 x 240	MV 65 180	MV 65 280
		41 x 29 x 1030	MV 65 171	MV 65 271
		41 x 29 x 1990	MV 65 172	MV 65 272
		41 x 29 x 3030	MV 65 173	MV 65 273
		41 x 41 x 1030	MV 65 174	MV 65 274
		41 x 41 x 1990	MV 65 175	MV 65 275
		41 x 41 x 3030	MV 65 176	MV 65 276
SUPORTURI		145	MV 61 100	MV 61 200
		245	MV 61 101	MV 61 201
		345	MV 61 102	MV 61 202
		445	MV 61 103	MV 61 203
		545	MV 61 104	MV 61 204
	Wall brackets	595	MV 61 105	MV 61 205
		645	MV 61 106	MV 61 206
		100		MV 61 290
		200		MV 61 292
		300		MV 61 294
Suport cu placa de fixare 41 x 29	400		MV 61 295	
	500		MV 61 296	
	600		MV 61 297	
	150		MV 61 231	
	200		MV 61 232	
Suport cu placa de fixare 41 x 41	300		MV 61 233	
	400		MV 61 234	
	150		MV 61 241	
	200		MV 61 242	
	300		MV 61 243	
		400		MV 61 244
		500		MV 61 245
		600		MV 61 246

PENTRU SARCINI MEDII

	GAMA C40 Pluriel		
	Descriere	Lungime (mm)	Z 275
ACCESORII	Semi-flansa pentru tavan		MV 64 180
	Flansa de conexiune pentru profil dublu		MV 64 181
	Carlig		MV 64 682
	PVC terminal protectie		MV 64 783
	MONTANTI		200
500			MV 65 191
1000			MV 65 192
2000			MV 65 193
SUPORTI		100	MV 61 160
		150	MV 61 161
		200	MV 61 162
		300	MV 61 163
		400	MV 61 164
500	MV 61 165		

Dimensiuni LxH (mm)	JGHEAB					ACCESORII						ELEMENTE DE CUPLARE		
	Elemente drepte					Capac			Separator			Rapid, compact, automat		
	Z 100	EZ	GAC	HP	Otel inox	Z 275	GAC	Otel inox	Z 275	GAC	Otel inox	Z 275	GAC	HP
50x30	MV 50 520	MV 50 420	MV 50 220	MV 50 720	MV 50 620	MV 50 150	MV 50 250	MV 50 650	MV 65 110	MV 65 210	MV 65 610	MV 51 113	MV 51 213	MV 51 713
100x30	MV 50 521	MV 50 421	MV 50 221	MV50721	MV 50 621	MV 50 151	MV 50 251	MV 50 651	MV 65 110	MV 65 210	MV 65 610	MV 51 113	MV 51 213	MV 51 713
150x30	MV 50 522	MV 50 422	MV 50 222	MV 50 722	MV 50 622	MV 50 152	MV 50 252	MV 50 652	MV 65 110	MV 65 210	MV 65 610	MV 51 113	MV 51 213	MV 51 713
200x30	MV 50 523	MV 50 423	MV 50 223	MV 50 723	MV 50 623	MV 50 153	MV 50 253	MV 50 653	MV 65 110	MV 65 210	MV 65 610	MV 51 113	MV 51 213	MV 51 713
300x30	MV 50 525	MV 50 425	MV 50 225	MV 50 725	MV 50 625	MV 50 155	MV 50 255	MV 50 655	MV 65 110	MV 65 210	MV 65 610	MV 51 114	MV 51 214	MV 51 714
50x60	MV 50 530	MV 50 430	MV 50 230	MV 50 730	MV 50 630	MV 50 150	MV 50 250	MV 50 650	MV 65 111	MV 65 211	MV 65 611	MV 51 113	MV 51 213	MV 51 713
100x60	MV 50 531	MV 50 431	MV 50 231	MV 50 731	MV 50 631	MV 50 151	MV 50 251	MV 50 651	MV 65 111	MV 65 211	MV 65 611	MV 51 113	MV 51 213	MV 51 713
150x60	MV 50 532	MV 50 432	MV 50 232	MV 50 732	MV 50 632	MV 50 152	MV 50 252	MV 50 652	MV 65 111	MV 65 211	MV 65 611	MV 51 113	MV 51 213	MV 51 713
200x60	MV 50 533	MV 50 433	MV 50 233	MV 50 733	MV 50 633	MV 50 153	MV 50 253	MV 50 653	MV 65 111	MV 65 211	MV 65 611	MV 51 113	MV 51 213	MV 51 713
250x60	MV 50 534	MV 50 434	MV 50 234	MV 50 734		MV 50 154	MV 50 254		MV 65 111	MV 65 211	MV 65 611	MV 51 114	MV 51 214	MV 51 714
300x60	MV 50 535	MV 50 435	MV 50 235	MV 50 735	MV 50 635	MV 50 155	MV 50 255	MV 50 655	MV 65 111	MV 65 211	MV 65 611	MV 51 114	MV 51 214	MV 51 714
400x60	MV 50 536	MV 50 436	MV 50 236	MV 50 736	MV 50 636	MV 50 156	MV 50 256	MV 50 656	MV 65 111	MV 65 211	MV 65 611	MV 51 115	MV 51 215	MV 51 715
500x60	MV 50 537	MV 50 437	MV 50 237	MV 50 737	MV 50 637	MV 50 157	MV 50 257	MV 50 657	MV 65 111	MV 65 211	MV 65 611	MV 51 115	MV 51 215	MV 51 715
600x60	MV 50 538	MV 50 438	MV 50 238	MV 50 738	MV 50 638	MV 50 158	MV 50 258	MV 50 658	MV 65 111	MV 65 211	MV 65 611	MV 51 115	MV 51 215	MV 51 715
150 x 110	MV 50 542	MV 50 442	MV 50 242	MV 50 742	MV 50 642	MV 50 152	MV 50 252	MV 50 652	MV 65 113	MV 65 213	MV 65 613	MV 51 114	MV 51 214	MV 51 714
200x110	MV 50 543	MV 50 443	MV 50 243	MV 50 743	MV 50 643	MV 50 153	MV 50 253	MV 50 653	MV 65 113	MV 65 213	MV 65 613	MV 51 114	MV 51 214	MV 51 714
300x110	MV 50 545	MV 50 445	MV 50 245	MV 50 745	MV 50 645	MV 50 155	MV 50 255	MV 50 655	MV 65 113	MV 65 213	MV 65 613	MV 51 115	MV 51 215	MV 51 715
400x110	MV 50 546	MV 50 446	MV 50 246	MV 50 746	MV 50 646	MV 50 156	MV 50 256	MV 50 656	MV 65 113	MV 65 213	MV 65 613	MV 51 115	MV 51 215	MV 51 715
500x110	MV 50 547	MV 50 447	MV 50 247	MV 50 747	MV 50 647	MV 50 157	MV 50 257	MV 50 657	MV 65 113	MV 65 213	MV 65 613	MV 51 115	MV 51 215	MV 51 715
600x110	MV 50 548	MV 50 448	MV 50 248	MV 50 748	MV 50 648	MV 50 158	MV 50 258	MV 50 658	MV 65 113	MV 65 213	MV 65 613	MV 51 115	MV 51 215	MV 51 715

Dimensiuni LxH (mm)	ELEMENTE DE CUPLARE															
	Imbinare automata rapida				Element drept de cuplare cu suruburi				Imbinari cu suruburi							
	Z 275	GAC	HP	Otel inox	Z 275	GAC	Otel inox	BICHRO		DACRO		Otel inox				
50x30	MV 51 110	MV 51 210	MV 51 710	MV 51 810				MV 66 403	MV 51 420	MV 51 421	MV 66 203	MV 51 220	MV 51 221	MV 66 820	MV 51 820	MV 51 821
100x30	MV 51 110	MV 51 210	MV 51 710	MV 51 810				MV 66 403	MV 51 420	MV 51 421	MV 66 203	MV 51 220	MV 51 221	MV 66 820	MV 51 820	MV 51 821
150x30	MV 51 110	MV 51 210	MV 51 710	MV 51 810				MV 66 403	MV 51 420	MV 51 421	MV 66 203	MV 51 220	MV 51 221	MV 66 820	MV 51 820	MV 51 821
200x30	MV 51 110	MV 51 210	MV 51 710	MV 51 810				MV 66 403	MV 51 420	MV 51 421	MV 66 203	MV 51 220	MV 51 221	MV 66 820	MV 51 820	MV 51 821
300x30	MV 51 110	MV 51 210	MV 51 710	MV 51 810				MV 66 403	MV 51 420	MV 51 421	MV 66 203	MV 51 220	MV 51 221	MV 66 820	MV 51 820	MV 51 821
50x60	MV 51 110	MV 51 210	MV 51 710	MV 51 810	MV 51 123 MV 51 422	MV 51 223 MV 51 222	MV 51 823 MV 51 822	MV 66 403	MV 51 420	MV 51 421	MV 66 203	MV 51 220	MV 51 221	MV 66 820	MV 51 820	MV 51 821
100x60	MV 51 110	MV 51 210	MV 51 710	MV 51 810	MV 51 123 MV 51 422	MV 51 223 MV 51 222	MV 51 823 MV 51 822	MV 66 403	MV 51 420	MV 51 421	MV 66 203	MV 51 220	MV 51 221	MV 66 820	MV 51 820	MV 51 821
150x60	MV 51 110	MV 51 210	MV 51 710	MV 51 810	MV 51 123 MV 51 422	MV 51 223 MV 51 222	MV 51 823 MV 51 822	MV 66 403	MV 51 420	MV 51 421	MV 66 203	MV 51 220	MV 51 221	MV 66 820	MV 51 820	MV 51 821
200x60	MV 51 110	MV 51 210	MV 51 710	MV 51 810	MV 51 123 MV 51 422	MV 51 223 MV 51 222	MV 51 823 MV 51 822	MV 66 403	MV 51 420	MV 51 421	MV 66 203	MV 51 220	MV 51 221	MV 66 820	MV 51 820	MV 51 821
250x60	MV 51 110	MV 51 210	MV 51 710	MV 51 810	MV 51 123 MV 51 422	MV 51 223 MV 51 222	MV 51 823 MV 51 822	MV 66 403	MV 51 420	MV 51 421	MV 66 203	MV 51 220	MV 51 221	MV 66 820	MV 51 820	MV 51 821
300x60	MV 51 110	MV 51 210	MV 51 710	MV 51 810	MV 51 123 MV 51 422	MV 51 223 MV 51 222	MV 51 823 MV 51 822	MV 66 403	MV 51 420	MV 51 421	MV 66 203	MV 51 220	MV 51 221	MV 66 820	MV 51 820	MV 51 821
400x60	MV 51 110	MV 51 210	MV 51 710	MV 51 810	MV 51 123 MV 51 422	MV 51 223 MV 51 222	MV 51 823 MV 51 822	MV 66 403	MV 51 420	MV 51 421	MV 66 203	MV 51 220	MV 51 221	MV 66 820	MV 51 820	MV 51 821
500x60	MV 51 110	MV 51 210	MV 51 710	MV 51 810	MV 51 123 MV 51 422	MV 51 223 MV 51 222	MV 51 823 MV 51 822	MV 66 403	MV 51 420	MV 51 421	MV 66 203	MV 51 220	MV 51 221	MV 66 820	MV 51 820	MV 51 821
600x60	MV 51 110	MV 51 210	MV 51 710	MV 51 810	MV 51 123 MV 51 422	MV 51 223 MV 51 222	MV 51 823 MV 51 822	MV 66 403	MV 51 420	MV 51 421	MV 66 203	MV 51 220	MV 51 221	MV 66 820	MV 51 820	MV 51 821
150 x 110	MV 51 110	MV 51 210	MV 51 710	MV 51 810	MV 51 123 MV 51 422	MV 51 223 MV 51 222	MV 51 823 MV 51 822	MV 66 403	MV 51 420	MV 51 421	MV 66 203	MV 51 220	MV 51 221	MV 66 820	MV 51 820	MV 51 821
200x110	MV 51 110	MV 51 210	MV 51 710	MV 51 810	MV 51 123 MV 51 422	MV 51 223 MV 51 222	MV 51 823 MV 51 822	MV 66 403	MV 51 420	MV 51 421	MV 66 203	MV 51 220	MV 51 221	MV 66 820	MV 51 820	MV 51 821
300x110	MV 51 110	MV 51 210	MV 51 710	MV 51 810	MV 51 123 MV 51 422	MV 51 223 MV 51 222	MV 51 823 MV 51 822	MV 66 403	MV 51 420	MV 51 421	MV 66 203	MV 51 220	MV 51 221	MV 66 820	MV 51 820	MV 51 821
400x110	MV 51 110	MV 51 210	MV 51 710	MV 51 810	MV 51 123 MV 51 422	MV 51 223 MV 51 222	MV 51 823 MV 51 822	MV 66 403	MV 51 420	MV 51 421	MV 66 203	MV 51 220	MV 51 221	MV 66 820	MV 51 820	MV 51 821
500x110	MV 51 110	MV 51 210	MV 51 710	MV 51 810	MV 51 123 MV 51 422	MV 51 223 MV 51 222	MV 51 823 MV 51 822	MV 66 403	MV 51 420	MV 51 421	MV 66 203	MV 51 220	MV 51 221	MV 66 820	MV 51 820	MV 51 821
600x110	MV 51 110	MV 51 210	MV 51 710	MV 51 810	MV 51 123 MV 51 422	MV 51 223 MV 51 222	MV 51 823 MV 51 822	MV 66 403	MV 51 420	MV 51 421	MV 66 203	MV 51 220	MV 51 221	MV 66 820	MV 51 820	MV 51 821

NOTA: pentru articolele disponibile cu otel inox 316 L, verificati paginile de catalog.

ACCESORII DE FIXARE SI SUSTINERE

Dimensiune LxH (mm)	Suport extern pentru tuburi rigide/doze			Suport de perete/ suport pentru doza		*Suporturi universale			Suport din otel inox AISI 304	** Suport suspensie			*** Suport pentru suspendat sau corpuri iluminat		
	Z 275	GAC	Otel inox	Z 275	GAC	Z 275	GAC	Otel inox	Otel inox	Z 275	GAC	Otel inox	Z 275	GAC	Otel inox
50x30	MV 51 101	MV 51 201	MV 51 601			MV 51 130	MV 51 230	MV 51 630	MV 64 670	MV 51 105	MV 51 205	MV 51 605	MV 51 107	MV 51 207	MV 51 607
100x30	MV 51 101	MV 51 201	MV 51 601			MV 51 130	MV 51 230	MV 51 630	MV 64 670	MV 51 105	MV 51 205	MV 51 605	MV 51 108	MV 51 208	MV 51 608
150x30	MV 51 101	MV 51 201	MV 51 601			MV 51 131	MV 51 231	MV 51 631	MV 64 671	MV 51 105	MV 51 205	MV 51 605	MV 51 108	MV 51 208	MV 51 608
200x30	MV 51 101	MV 51 201	MV 51 601			MV 51 132	MV 51 232	MV 51 632	MV 64 671	MV 51 105	MV 51 205	MV 51 605	MV 51 108	MV 51 208	MV 51 608
300x30	MV 51 101	MV 51 201	MV 51 601			MV 51 133	MV 51 233	MV 51 633	MV 64 672	MV 51 105	MV 51 205	MV 51 605	MV 51 108	MV 51 208	MV 51 608
50x60	MV51 101	MV 51 201	MV 51 601	MV 51 103	MV 51 203	MV 51 130	MV 51 230	MV 51 630	MV 64 670	MV 51 105	MV 51 205	MV 51 605	MV 51 107	MV 51 207	MV 51 607
100x60	MV 51 101	MV 51 201	MV 51 601	MV 51 103	MV 51 203	MV 51 130	MV 51 230	MV 51 630	MV 64 670	MV 51 105	MV 51 205	MV 51 605	MV 51 108	MV 51 208	MV 51 608
150x60	MV 51 101	MV 51 201	MV 51 601	MV 51 103	MV 51 203	MV 51 131	MV 51 231	MV 51 631	MV 64 671	MV 51 105	MV 51 205	MV 51 605	MV 51 108	MV 51 208	MV 51 608
200x60	MV 51 101	MV 51 201	MV 51 601	MV 51 103	MV 51 203	MV 51 132	MV 51 232	MV 51 632	MV 64 671	MV 51 105	MV 51 205	MV 51 605	MV 51 108	MV 51 208	MV 51 608
250x60	MV 51 101	MV 51 201	MV 51 601	MV 51 103	MV 51 203	MV 51 133	MV 51 233	MV 51 633	MV 64 672	MV 51 105	MV 51 205	MV 51 605	MV 51 108	MV 51 208	MV 51 608
300x60	MV 51 101	MV 51 201	MV 51 601	MV 51 103	MV 51 203	MV 51 133	MV 51 233	MV 51 633	MV 64 672	MV 51 105	MV 51 205	MV 51 605	MV 51 108	MV 51 208	MV 51 608
400x60	MV 51 101	MV 51 201	MV 51 601	MV 51 103	MV 51 203	MV 51 134	MV 51 234	MV 51 634	MV 64 673	MV 51 105	MV 51 205	MV 51 605	MV 51 108	MV 51 208	MV 51 608
500x60	MV 51 101	MV 51 201	MV 51 601	MV 51 103	MV 51 203	MV 51 135	MV 51 235	MV 51 635	MV 64 674	MV 51 105	MV 51 205	MV 51 605	MV 51 108	MV 51 208	MV 51 608
600x60	MV 51 101	MV 51 201	MV 51 601	MV 51 103	MV 51 203	MV 51 136	MV 51 236	MV 51 639		MV 51 105	MV 51 205	MV 51 605	MV 51 108	MV 51 208	MV 51 608
150 x 110	MV 51 101	MV 51 201	MV 51 601	MV 51 103	MV 51 203	MV 51 131	MV 51 231	MV 51 631	MV 64 671	MV 51 105	MV 51 205	MV 51 605	MV 51 108	MV 51 208	MV 51 608
200x110	MV 51 101	MV 51 201	MV 51 601	MV 51 103	MV 51 203	MV 51 132	MV 51 232	MV 51 632	MV 64 671	MV 51 105	MV 51 205	MV 51 605	MV 51 108	MV 51 208	MV 51 608
300x110	MV 51 101	MV 51 201	MV 51 601	MV 51 103	MV 51 203	MV 51 133	MV 51 233	MV 51 633	MV 64 672	MV 51 105	MV 51 205	MV 51 605	MV 51 108	MV 51 208	MV 51 608
400x110	MV 51 101	MV 51 201	MV 51 601	MV 51 103	MV 51 203	MV 51 134	MV 51 234	MV 51 634	MV 64 673	MV 51 105	MV 51 205	MV 51 605	MV 51 108	MV 51 208	MV 51 608
500x110	MV 51 101	MV 51 201	MV 51 601	MV 51 103	MV 51 203	MV 51 135	MV 51 235	MV 51 635	MV 64 674	MV 51 105	MV 51 205	MV 51 605	MV 51 108	MV 51 208	MV 51 608
600x110	MV 51 101	MV 51 201	MV 51 601	MV 51 103	MV 51 203	MV 51 136	MV 51 236	MV 51 639		MV 51 105	MV 51 205	MV 51 605	MV 51 108	MV 51 208	MV 51 608

ECHIPAMENTE PENTRU TAIAT SI INDOIT	Cleste cu lame asimetrice		ACCESORII	Terminal impamantare	
				MV 51 904	
	Masina automata de curbat	Lame rezerva		Placuta identificare	
	MV 51 943	MV 51 945		MV 51 947	

* Pentru suspendare, alegeti dimensiunea imediat urmatoare si doua bare filetate Ø 6 sau Ø 10



** Folositi bara filetata cu Ø 8 si nit de siguranta (Cod MV 51086)

*** Folositi 2 placi si 1 bara filetata cu Ø 6 pt suspendare

Utilizat cu cupla universala min. L 400 mm si cu tija filetata ø 10 pentru suspendare.

NOTE: pentru articolele disponibile din otel inox 316 L, va rugam sa consultati paginile de catalog.

Dimensiuni LxH (mm)	ELEMENTE DREPTE			ELEMENT DE CUPLARE	SEPARATOR	RACORDURI				COMPONENTE DE TRASEU	
	Jgheab	Capac	Agrafa pentru capac			Imbinare automata rapida	Imbinare cu suruburi	Imbinare flexibila cu suruburi**	Imbinare rigida cu suruburi**	Orizantal	
	Z 275	Z 275	otel inox	Z 275	Z 275	Z 275	Z 275	Z 275	Z 275	Cot 90°	Capac unghi 90°
65x35	MV 40 100	MV 40 180	MV 41 601		MV 65 110	MV 41 110	MV 41 120	MV 41 130	MV 41 120	MV 42 100	MV 42 180
95x35	MV 40 101	MV 40 181	MV 41 601		MV 65 110	MV 41 110	MV 41 120	MV 41 130	MV 41 120	MV 42 101	MV 42 181
125x35	MV 40 102	MV 40 182	MV 41 601		MV 65 110	MV 41 110	MV 41 120	MV 41 130	MV 41 120	MV 42 102	MV 42 182
155x35	MV 40 103	MV 40 183	MV 41 601		MV 65 110	MV 41 110	MV 41 120	MV 41 130	MV 41 120	MV 42 103	MV 42 183
185x35	MV 40 104	MV 40 184	MV 41 601		MV 65 110	MV 41 110	MV 41 120	MV 41 130	MV 41 120	MV 42 104	MV 42 184
215x35	MV 40 105	MV 40 185	MV 41 601		MV 65 110	MV 41 110	MV 41 120	MV 41 130	MV 41 120	MV 42 105	MV 42 185
245x35	MV 40 106	MV 40 186	MV 41 601		MV 65 110	MV 41 110	MV 41 120	MV 41 130	MV 41 120	MV 42 106	MV 42 186
305x35	MV 40 108	MV 40 188	MV 41 601		MV 65 110	MV 41 110	MV 41 120	MV 41 130	MV 41 120	MV 42 108	MV 42 188
365x35	MV 40 110	MV 40 190	MV 41 601		MV 65 110	MV 41 110	MV 41 120	MV 41 130	MV 41 120	MV 42 110	MV 42 190
395x35	MV 40 111	MV 40 191	MV 41 601	MV 48 151	MV 65 110	MV 41 110	MV 41 120	MV 41 130	MV 41 120	MV 42 111	MV 42 191
65x50	MV 40 120	MV 40 180	MV 41 602		MV 65 111	MV 41 111	MV 41 120	MV 41 130	MV 41 120	MV 42 120	MV 42 180
95x50	MV 40 121	MV 40 181	MV 41 602		MV 65 111	MV 41 111	MV 41 120	MV 41 130	MV 41 120	MV 42 121	MV 42 181
125x50	MV 40 122	MV 40 182	MV 41 602		MV 65 111	MV 41 111	MV 41 120	MV 41 130	MV 41 120	MV 42 122	MV 42 182
155x50	MV 40 123	MV 40 183	MV 41 602		MV 65 111	MV 41 111	MV 41 120	MV 41 130	MV 41 120	MV 42 123	MV 42 183
185x50	MV 40 124	MV 40 184	MV 41 602		MV 65 111	MV 41 111	MV 41 120	MV 41 130	MV 41 120	MV 42 124	MV 42 184
215x50	MV 40 125	MV 40 185	MV 41 602		MV 65 111	MV 41 111	MV 41 120	MV 41 130	MV 41 120	MV 42 125	MV 42 185
245x50	MV 40 126	MV 40 186	MV 41 602		MV 65 111	MV 41 111	MV 41 120	MV 41 130	MV 41 120	MV 42 126	MV 42 186
305x50	MV 40 128	MV 40 188	MV 41 602		MV 65 111	MV 41 111	MV 41 120	MV 41 130	MV 41 120	MV 42 128	MV 42 188
365x50	MV 40 130	MV 40 190	MV 41 602		MV 65 111	MV 41 111	MV 41 120	MV 41 130	MV 41 120	MV 42 130	MV 42 190
395x50	MV 40 131	MV 40 191	MV 41 602	MV 48 151	MV 65 111	MV 41 111	MV 41 120	MV 41 130	MV 41 120	MV 42 131	MV 42 191
515x50	MV 40 135	MV 40 195	MV 41 602	MV 48 155	MV 65 111	MV 41 111	MV 41 120	MV 41 130	MV 41 120	MV 42 135	MV 42 195
95x65	MV 40 141	MV 40 181	MV 41 603		MV 65 112		MV 41 121	MV 41 131	MV 41 140	MV 42 141	MV 42 181
215x65	MV 40 145	MV 40 185	MV 41 603		MV 65 112		MV 41 121	MV 41 131	MV 41 140	MV 42 145	MV 42 185
305x65	MV 40 148	MV 40 188	MV 41 603		MV 65 112		MV 41 121	MV 41 131	MV 41 140	MV 42 148	MV 42 188
395x65	MV 40 151	MV 40 191	MV 41 603	MV 48 151	MV 65 112		MV 41 121	MV 41 131	MV 41 140	MV 42 151	MV 42 191
515x65	MV 40 155	MV 40 195	MV 41 603	MV 48 155	MV 65 112		MV 41 121	MV 41 131	MV 41 140	MV 42 155	MV 42 195
605x65	MV 40 157	MV 40 197	MV 41 603	MV 48 157	MV 65 112		MV 41 121	MV 41 131	MV 41 140	MV 42 157	MV 42 197
125x80	MV 40 162	MV 40 182	MV 41 602		MV 65 113		MV 41 121	MV 41 131	MV 41 140	MV 42 162	MV 42 182
215x80	MV 40 165	MV 40 185	MV 41 602		MV 65 113		MV 41 121	MV 41 131	MV 41 140	MV 42 165	MV 42 185
305x80	MV 40 168	MV 40 188	MV 41 602		MV 65 113		MV 41 121	MV 41 131	MV 41 140	MV 42 168	MV 42 188
395x80	MV 40 171	MV 40 191	MV 41 602	MV 48 151	MV 65 113		MV 41 121	MV 41 131	MV 41 140	MV 42 171	MV 42 191
515x80	MV 40 175	MV 40 195	MV 41 602	MV 48 155	MV 65 113		MV 41 121	MV 41 131	MV 41 140	MV 42 175	MV 42 195
605x80	MV 40 177	MV 40 197	MV 41 602	MV 48 157	MV 65 113		MV 41 121	MV 41 131	MV 41 140	MV 42 177	MV 42 197

ACCESORII (SURUBURI CU PIULITA)					
Surub M6x10 + piulita		Surub M6x14 + piulita		Surub M6x20 + piulita	
					
Bichro	Dacro	Bichro	Dacro	Bichro	Dacro
GW 66 100	GW 66 200	GW 66 101	GW 66 201	GW 66 403	GW 66 203

** A se utiliza cu surubul MV66100.
Nota: Finisajul GAC disponibil la cerere.

NOTA: jgheaburile si accesoriile sunt disponibile in finisaje GAC si epoxy.

COMPONENTE DE TRASEU

COMPONENTE DE TRASEU											
Orizontal								Vertical			
Unghi la	Capac pentru unghi la 45°	Jonctiune in T	Element de jonctiune in T	Trecere orizontala	Capac pentru trecere orizontala	Iesire	Capac iesire	Urcare verticala	Capac pentru urcare verticala	Coborare verticala	Capac coborare verticala
Z 275	Z 275	Z 275	Z 275	Z 275	Z 275	Z 275	Z 275	Z 275	Z 275	Z 275	Z 275
MV 43 100	MV 43 180	MV 46 100	MV 46 180	MV 47 100	MV 47 180	MV 49 100	MV 49 180	MV 44 100	MV 24 100	MV 45 100	MV 25 100
MV 43 101	MV 43 181	MV 46 101	MV 46 181	MV 47 101	MV 47 181	MV 49 101	MV 49 181	MV 44 101	MV 24 101	MV 45 101	MV 25 101
MV 43 102	MV 43 182	MV 46 102	MV 46 182	MV 47 102	MV 47 182	MV 49 102	MV 49 182	MV 44 102	MV 24 102	MV 45 102	MV 25 102
MV 43 103	MV 43 183	MV 46 103	MV 46 183	MV 47 103	MV 47 183	MV 49 103	MV 49 183	MV 44 103	MV 24 103	MV 45 103	MV 25 103
MV 43 104	MV 43 184	MV 46 104	MV 46 184	MV 47 104	MV 47 184	MV 49 104	MV 49 184	MV 44 104	MV 24 104	MV 45 104	MV 25 104
MV 43 105	MV 43 185	MV 46 105	MV 46 185	MV 47 105	MV 47 185	MV 49 105	MV 49 185	MV 44 105	MV 24 105	MV 45 105	MV 25 105
MV 43 106	MV 43 186	MV 46 106	MV 46 186	MV 47 106	MV 47 186	MV 49 106	MV 49 186	MV 44 106	MV 24 106	MV 45 106	MV 25 106
MV 43 108	MV 43 188	MV 46 108	MV 46 188	MV 47 108	MV 47 188	MV 49 108	MV 49 188	MV 44 108	MV 24 108	MV 45 108	MV 25 108
MV 43 110	MV 43 190	MV 46 110	MV 46 190	MV 47 110	MV 47 190	MV 49 110	MV 49 190	MV 44 110	MV 24 110	MV 45 110	MV 25 110
MV 43 111	MV 43 191	MV 46 111	MV 46 191	MV 47 111	MV 47 191	MV 49 111	MV 49 191	MV 44 111	MV 24 111	MV 45 111	MV 25 111
MV 43 120	MV 43 180	MV 46 120	MV 46 180	MV 47 120	MV 47 180	MV 49 120	MV 49 180	MV 44 120	MV 24 120	MV 45 120	MV 25 120
MV 43 121	MV 43 181	MV 46 121	MV 46 181	MV 47 121	MV 47 181	MV 49 121	MV 49 181	MV 44 121	MV 24 121	MV 45 121	MV 25 121
MV 43 122	MV 43 182	MV 46 122	MV 46 182	MV 47 122	MV 47 182	MV 49 122	MV 49 182	MV 44 122	MV 24 122	MV 45 122	MV 25 122
MV 43 123	MV 43 183	MV 46 123	MV 46 183	MV 47 123	MV 47 183	MV 49 123	MV 49 183	MV 44 123	MV 24 123	MV 45 123	MV 25 123
MV 43 124	MV 43 184	MV 46 124	MV 46 184	MV 47 124	MV 47 184	MV 49 124	MV 49 184	MV 44 124	MV 24 124	MV 45 124	MV 25 124
MV 43 125	MV 43 185	MV 46 125	MV 46 185	MV 47 125	MV 47 185	MV 49 125	MV 49 185	MV 44 125	MV 24 125	MV 45 125	MV 25 125
MV 43 126	MV 43 186	MV 46 126	MV 46 186	MV 47 126	MV 47 186	MV 49 126	MV 49 186	MV 44 126	MV 24 126	MV 45 126	MV 25 126
MV 43 128	MV 43 188	MV 46 128	MV 46 188	MV 47 128	MV 47 188	MV 49 128	MV 49 188	MV 44 128	MV 24 128	MV 45 128	MV 25 128
MV 43 130	MV 43 190	MV 46 130	MV 46 190	MV 47 130	MV 47 190	MV 49 130	MV 49 190	MV 44 130	MV 24 130	MV 45 130	MV 25 130
MV 43 131	MV 43 191	MV 46 131	MV 46 191	MV 47 131	MV 47 191	MV 49 131	MV 49 191	MV 44 131	MV 24 131	MV 45 131	MV 25 131
MV 43 135	MV 43 195	MV 46 135	MV 46 195	MV 47 135	MV 47 195	MV 49 135	MV 49 195	MV 44 135	MV 24 135	MV 45 135	MV 25 135
MV 43 141	MV 43 181	MV 46 141	MV 46 181	MV 47 141	MV 47 181	MV 49 141	MV 49 181	MV 44 141	MV 24 141	MV 45 141	MV 25 141
MV 43 145	MV 43 185	MV 46 145	MV 46 185	MV 47 145	MV 47 185	MV 49 145	MV 49 185	MV 44 145	MV 24 145	MV 45 145	MV 25 145
MV 43 148	MV 43 188	MV 46 148	MV 46 188	MV 47 148	MV 47 188	MV 49 148	MV 49 188	MV 44 148	MV 24 148	MV 45 148	MV 25 148
MV 43 151	MV 43 191	MV 46 151	MV 46 191	MV 47 151	MV 47 191	MV 49 151	MV 49 191	MV 44 151	MV 24 151	MV 45 151	MV 25 151
MV 43 155	MV 43 195	MV 46 155	MV 46 195	MV 47 155	MV 47 195	MV 49 155	MV 49 195	MV 44 155	MV 24 155	MV 45 155	MV 25 155
MV 43 157	MV 43 197	MV 46 157	MV 46 197	MV 47 157	MV 47 197	MV 49 157	MV 49 197	MV 44 157	MV 24 157	MV 45 157	MV 25 157
MV 43 162	MV 43 182	MV 46 162	MV 46 182	MV 47 162	MV 47 182	MV 49 162	MV 49 182	MV 44 162	MV 24 162	MV 45 162	MV 25 162
MV 43 165	MV 43 185	MV 46 165	MV 46 185	MV 47 165	MV 47 185	MV 49 165	MV 49 185	MV 44 165	MV 24 165	MV 45 165	MV 25 165
MV 43 168	MV 43 188	MV 46 168	MV 46 188	MV 47 168	MV 47 188	MV 49 168	MV 49 188	MV 44 168	MV 24 168	MV 45 168	MV 25 168
MV 43 171	MV 43 191	MV 46 171	MV 46 191	MV 47 171	MV 47 191	MV 49 171	MV 49 191	MV 44 171	MV 24 171	MV 45 171	MV 25 171
MV 43 175	MV 43 195	MV 46 175	MV 46 195	MV 47 175	MV 47 195	MV 49 175	MV 49 195	MV 44 175	MV 24 175	MV 45 175	MV 25 175
MV 43 177	MV 43 197	MV 46 177	MV 46 197	MV 47 177	MV 47 197	MV 49 177	MV 49 197	MV 44 177	MV 24 177	MV 45 177	MV 25 177

NOTA: jgheaburile si accesoriile sunt disponibile in finisaje GAC si epoxy.

gewiss.com

GEWISS

DOMOTICS ENERGY LIGHTING

GEWISS ROMANIA SRL - Aurel Vlaicu Office Building, Sos. Pipera nr. 4, Etaj 4, Sector 1, Bucuresti
Tel. 00 40 314 370 653 - Fax 00 40 314 370 651 - gewiss@gewiss.com.ro - www.gewiss.com

Sole Shareholder company - Bergamo Register of Companies/ VAT / Tax code (IT) 00385040167 - REA 107496 - Share Capital 60,000,000.00 EUR fully paid up